

PLOT 4 FLOOR PLAN_AS PROPOSED 1:100 @ A3

Ground Floor Key

- 1. Entrance Hall
- 2. Living room
- 3. Kitchen
- 4. Dining
- 5. Sun room
- 6. Utility
- 7. W.C.
- 8. Cloaks

320180303

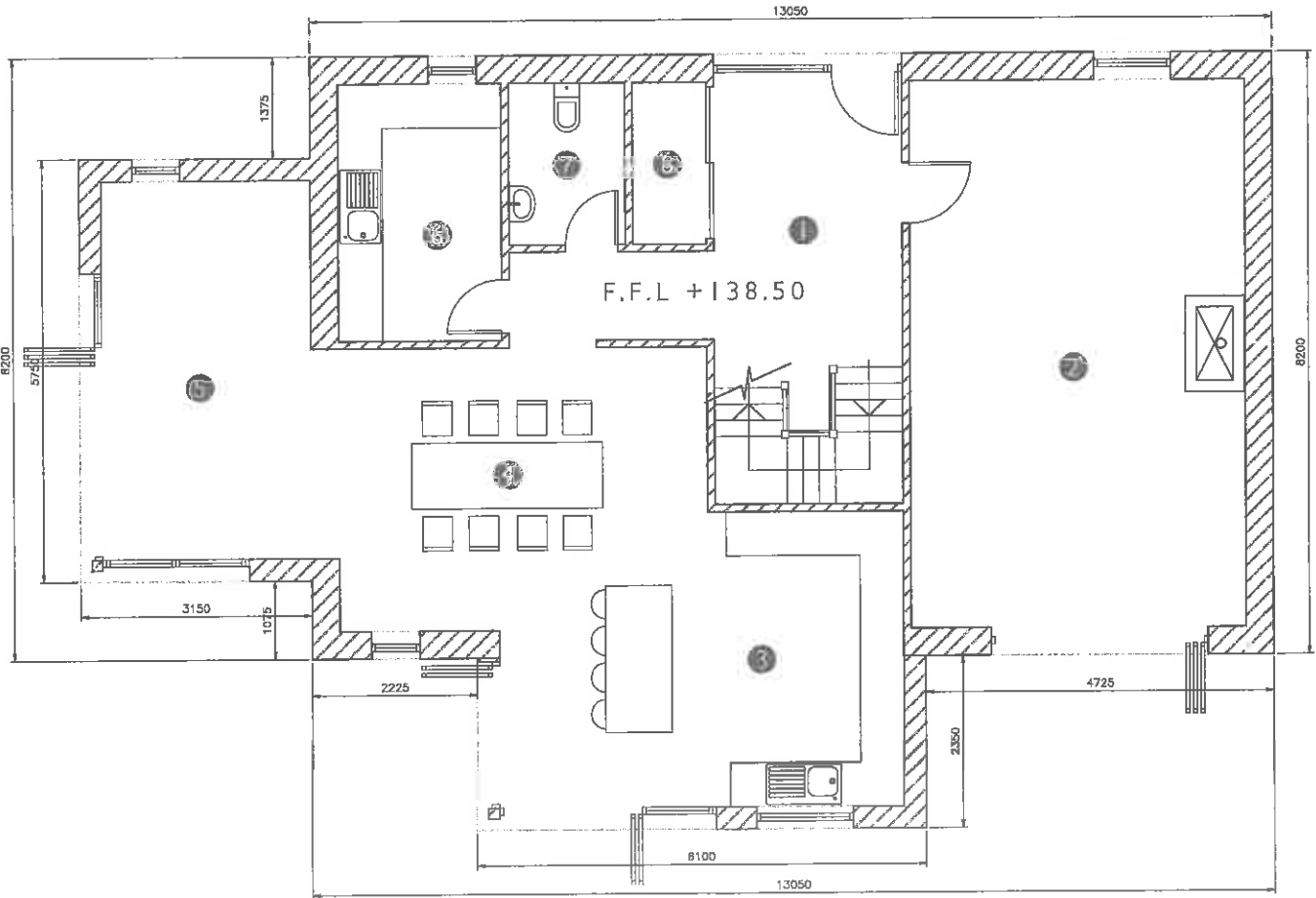

Ground Floor Plan

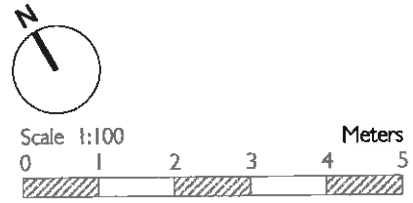

PLOT 4 FLOOR PLAN_AS PROPOSED 1:100 @ A3

First Floor Key

- 1. Master Bedroom
- 2. Bedroom 2
- 3. Bedroom 3
- 4. Bedroom 4
- 5. En-Suite
- 6. Bathroom
- 7. Landing
- 8. Void

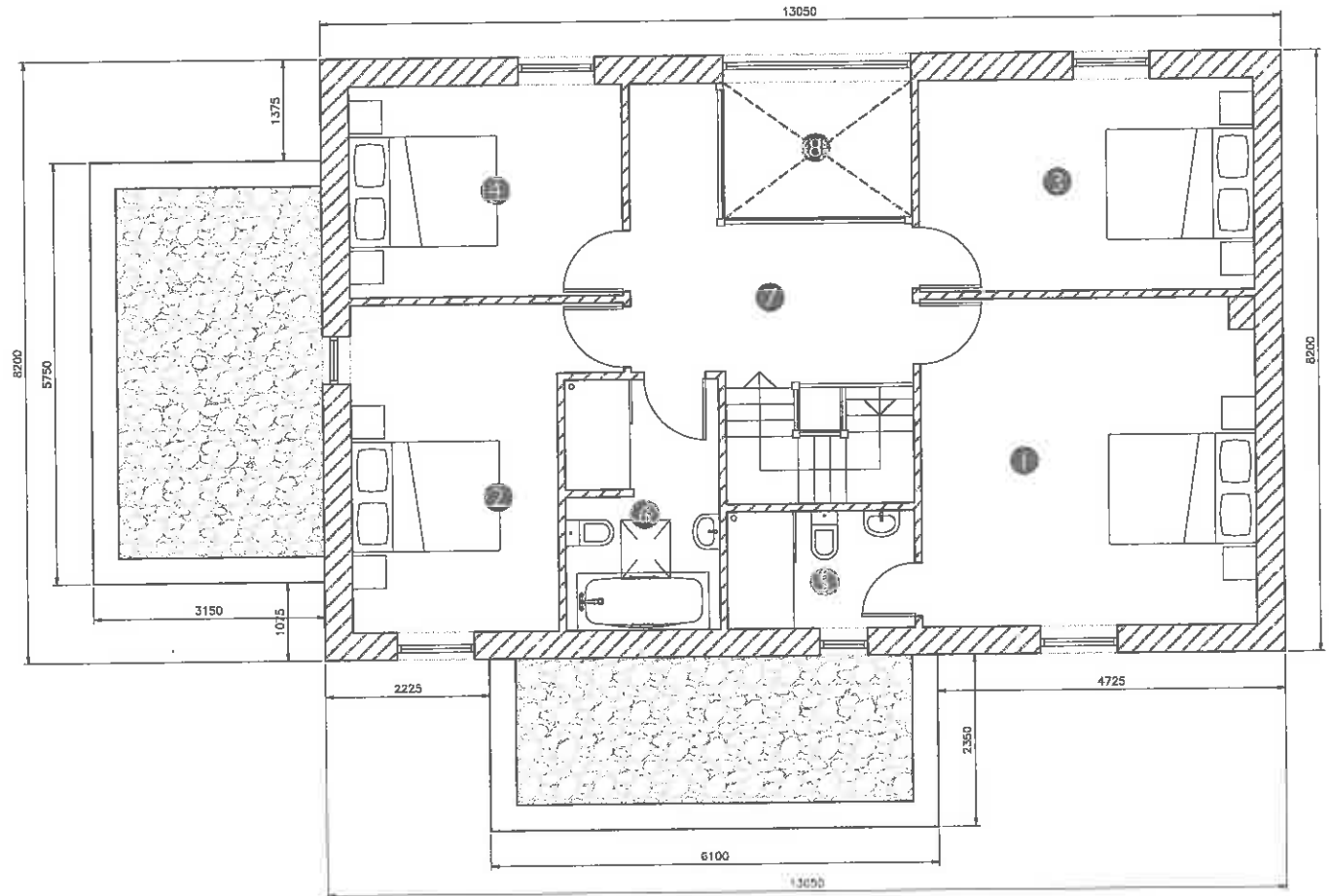

320180303

First Floor Plan

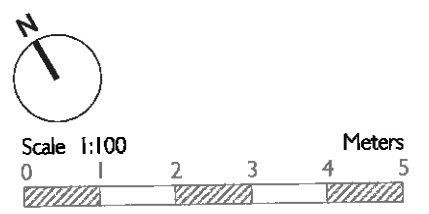

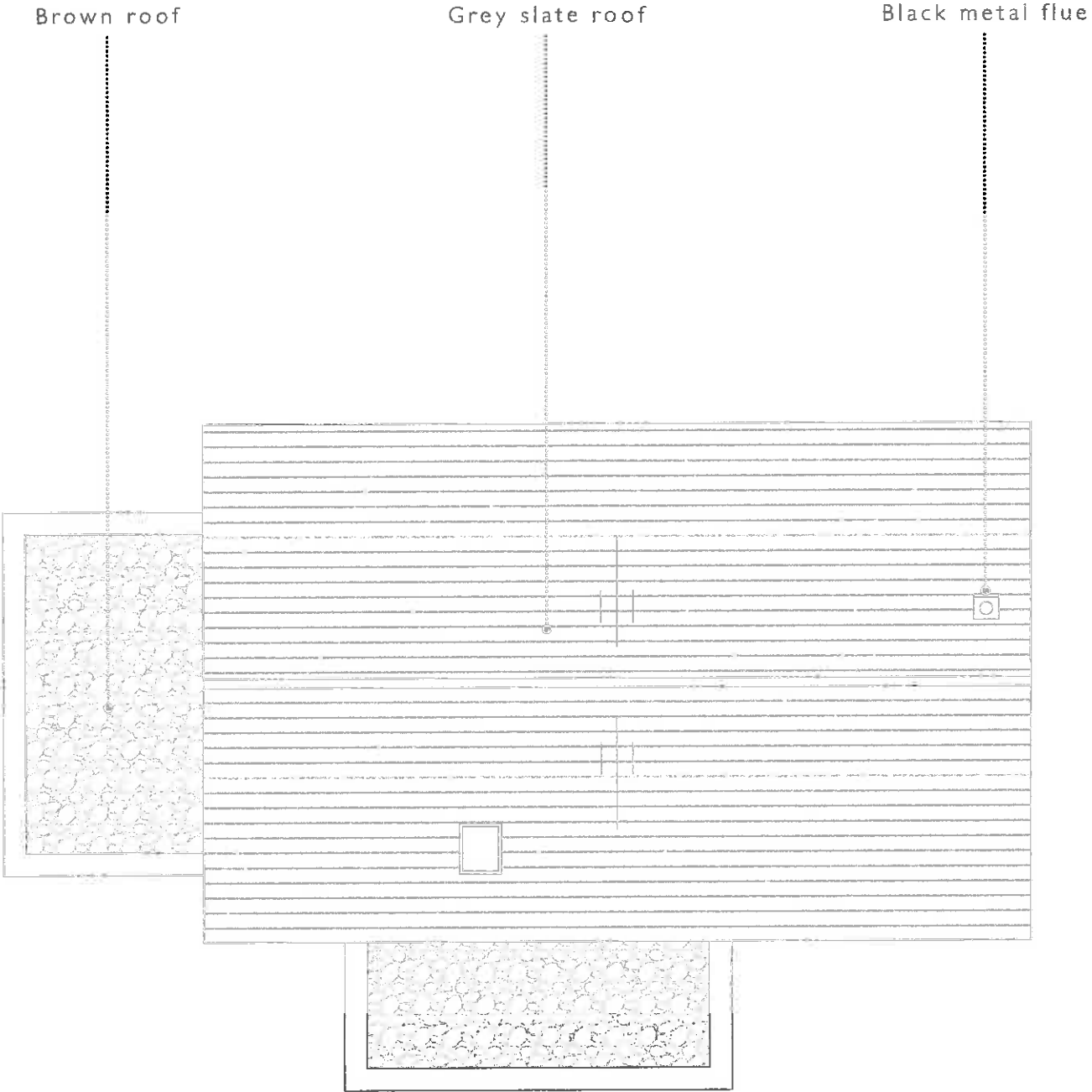

3201 80303

- ▼ EAVES HT +143.50
- ▼ EAVES HT +142.10
- ▼ RIDGE HT +145.90
- ▼ EAVES HT +142.10
- ▼ EAVES HT +143.50
- ▼ EAVES HT +141.60

Plot 4 Roof Plan

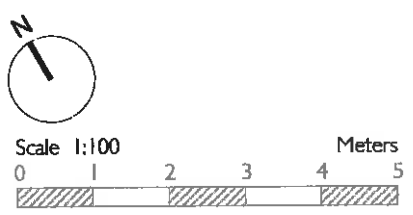

PLOT 4 ELEVATIONS_AS PROPOSED 1:100 @ A3

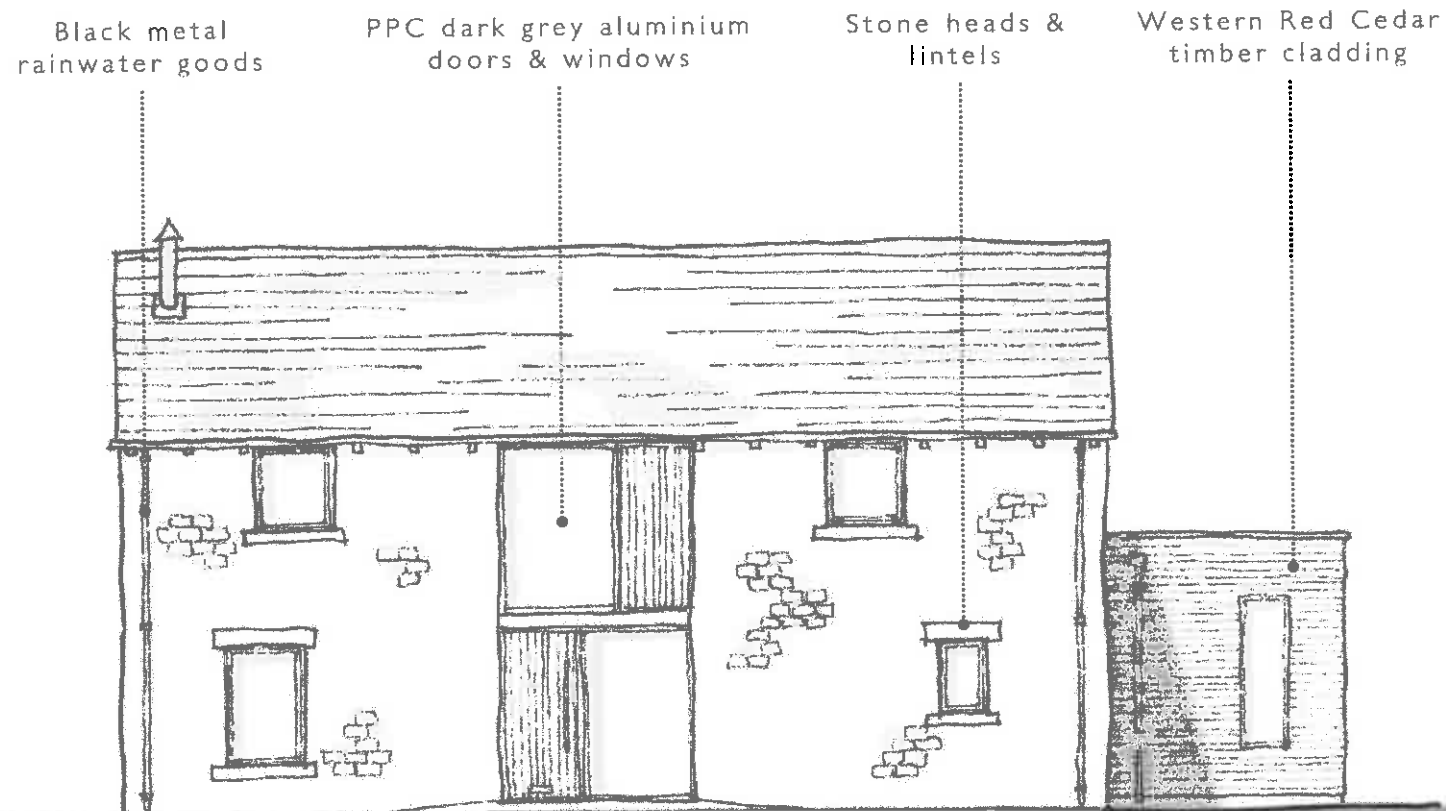

North West Elevation

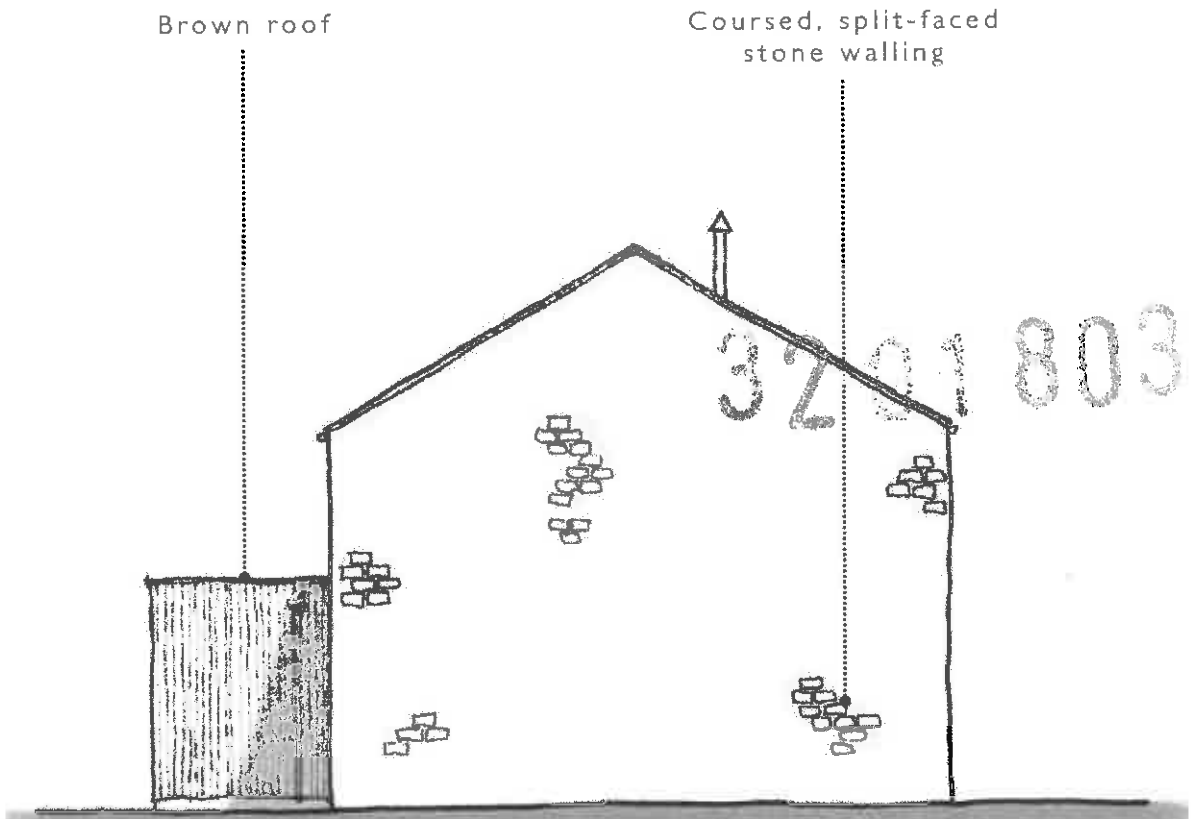

North East Elevation

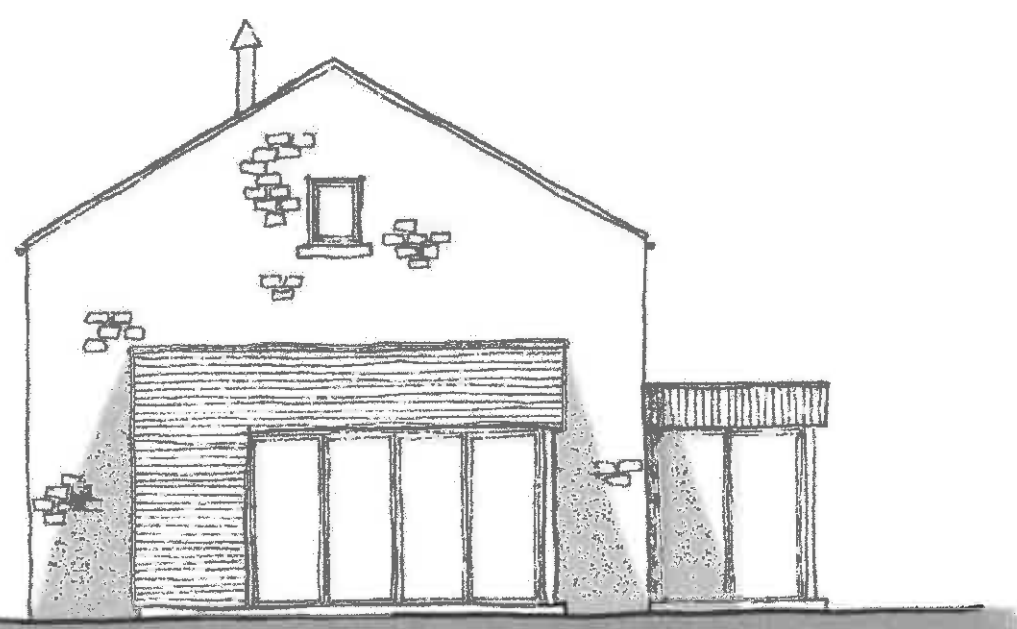

South West Elevation

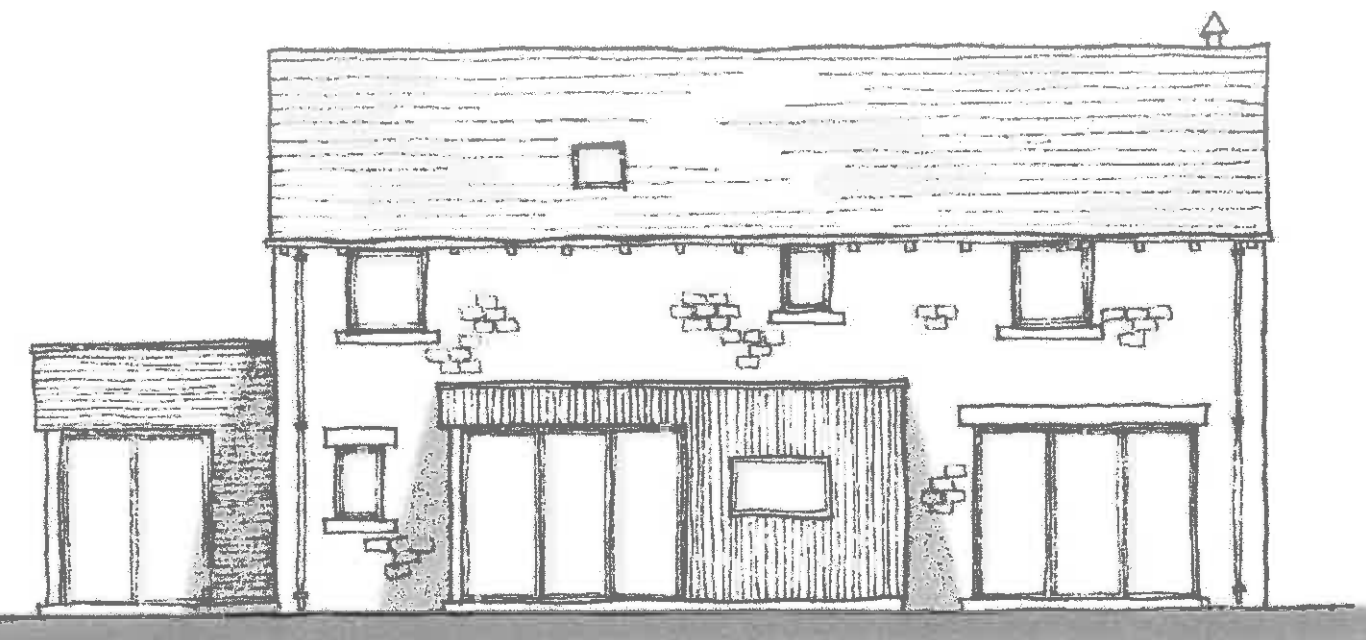

South East Elevation

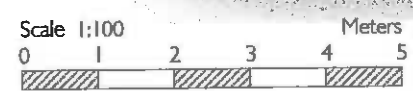

PLOT 4 CARPORT_AS PROPOSED 1:100 @ A3

Ground Floor Key

1. Carport

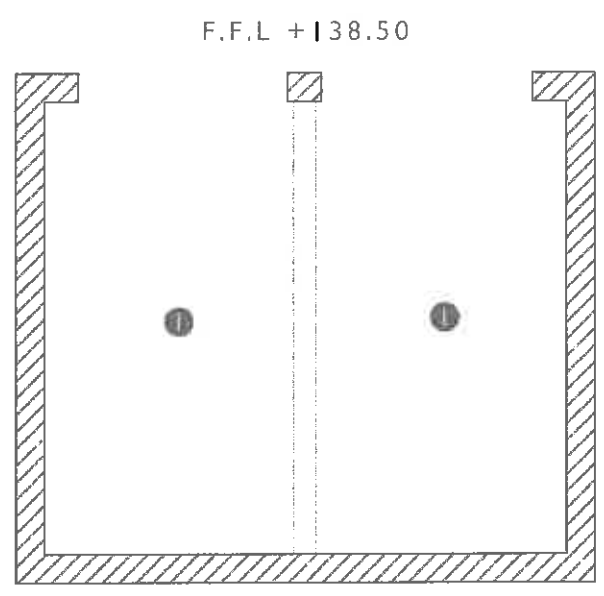

Floor Plan

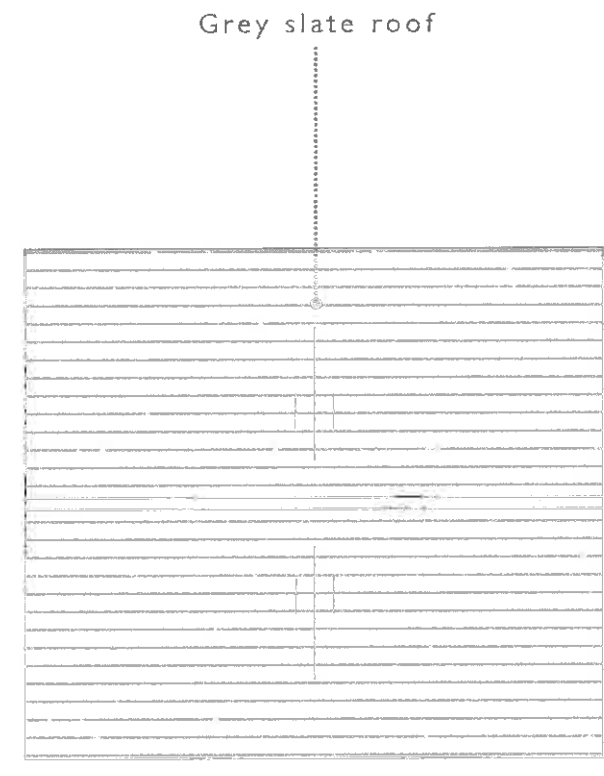

Roof Plan

▼ EAVES HT +141.00

320180303
▼ RIDGE HT +143.00

▼ EAVES HT +141.00

Stone heads

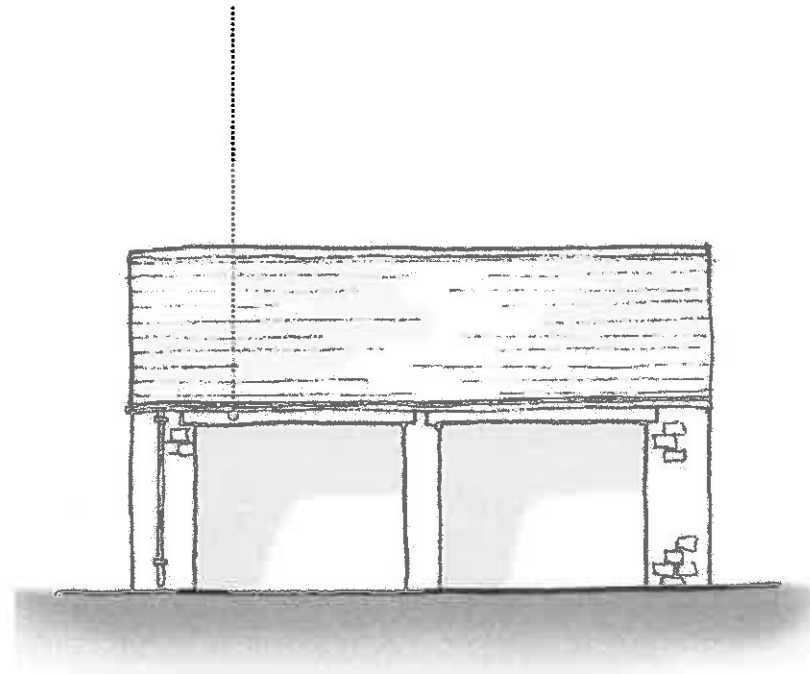

North West Elevation

Coursed stone walling

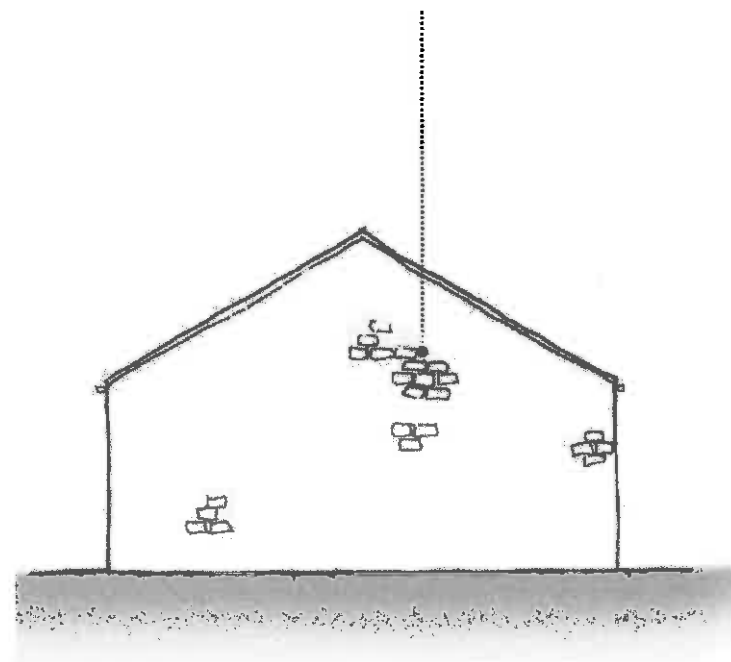

North East / South West Elevation

Metal rainwater goods

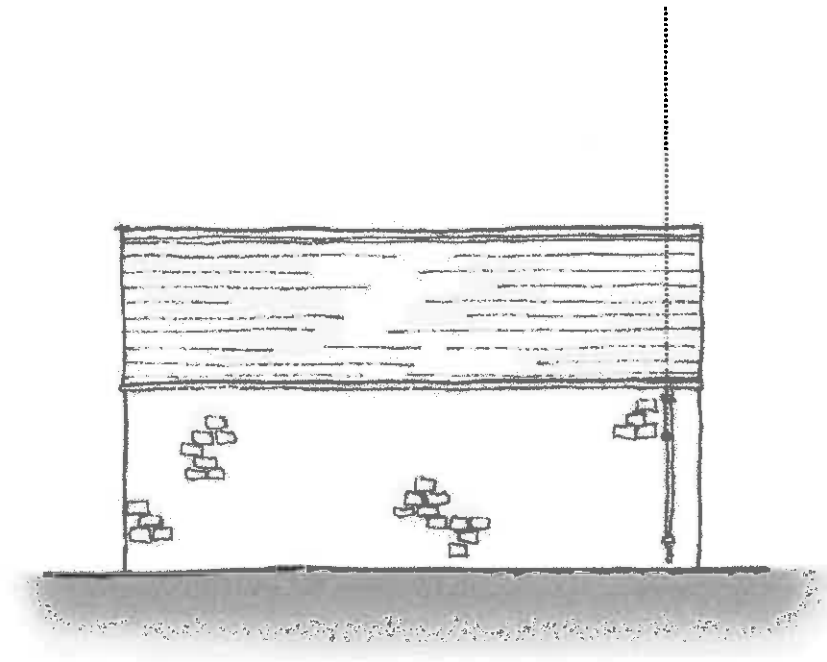

South East Elevation

