

320190316P

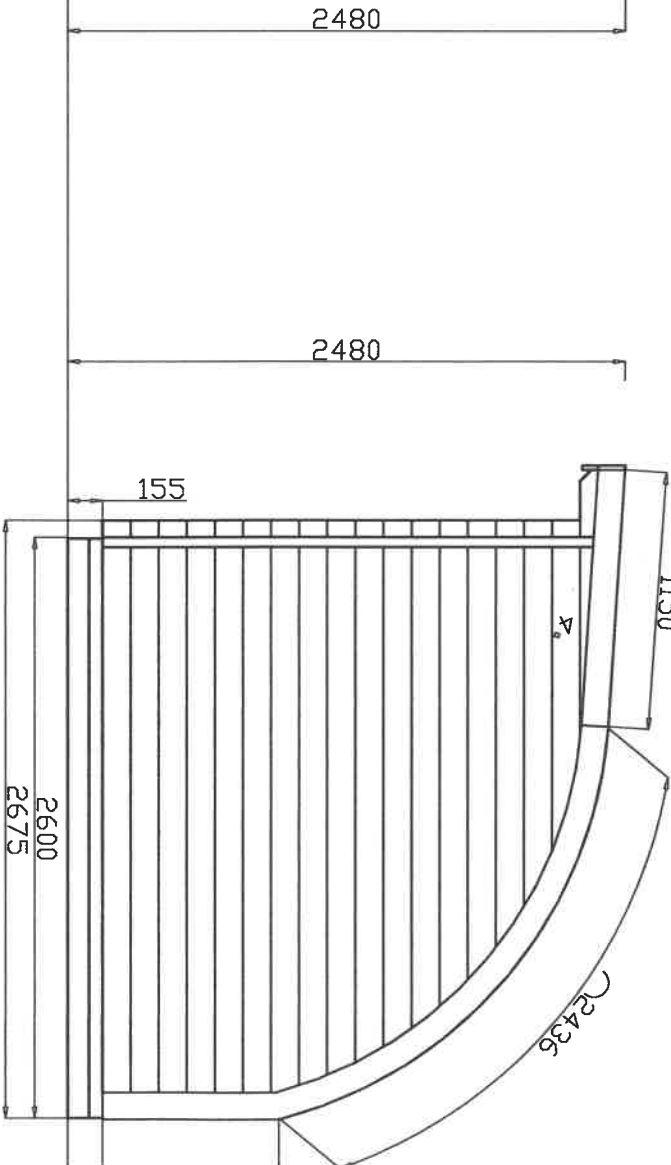

POD1 - 3026(44)LS3 (P01412-SHELL)

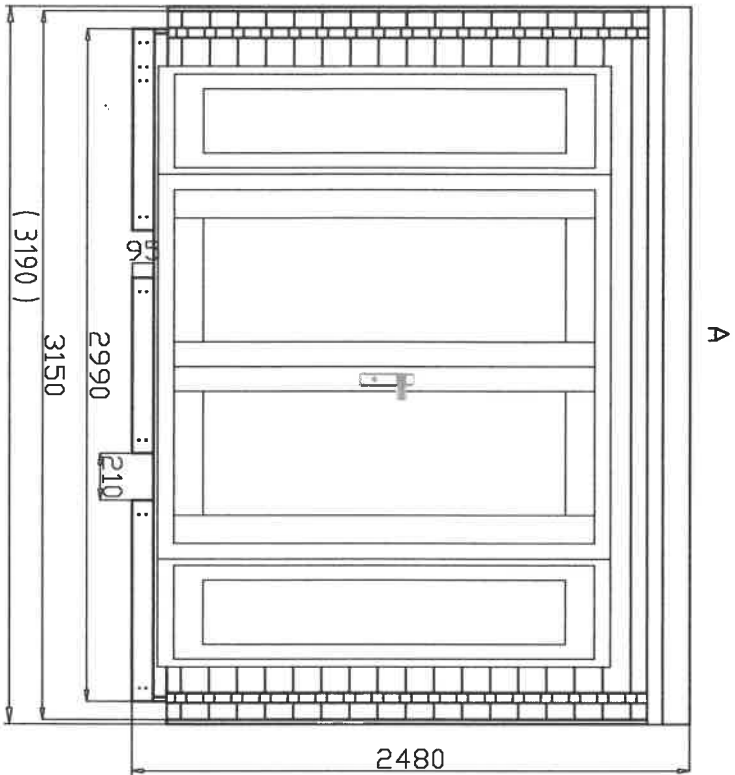

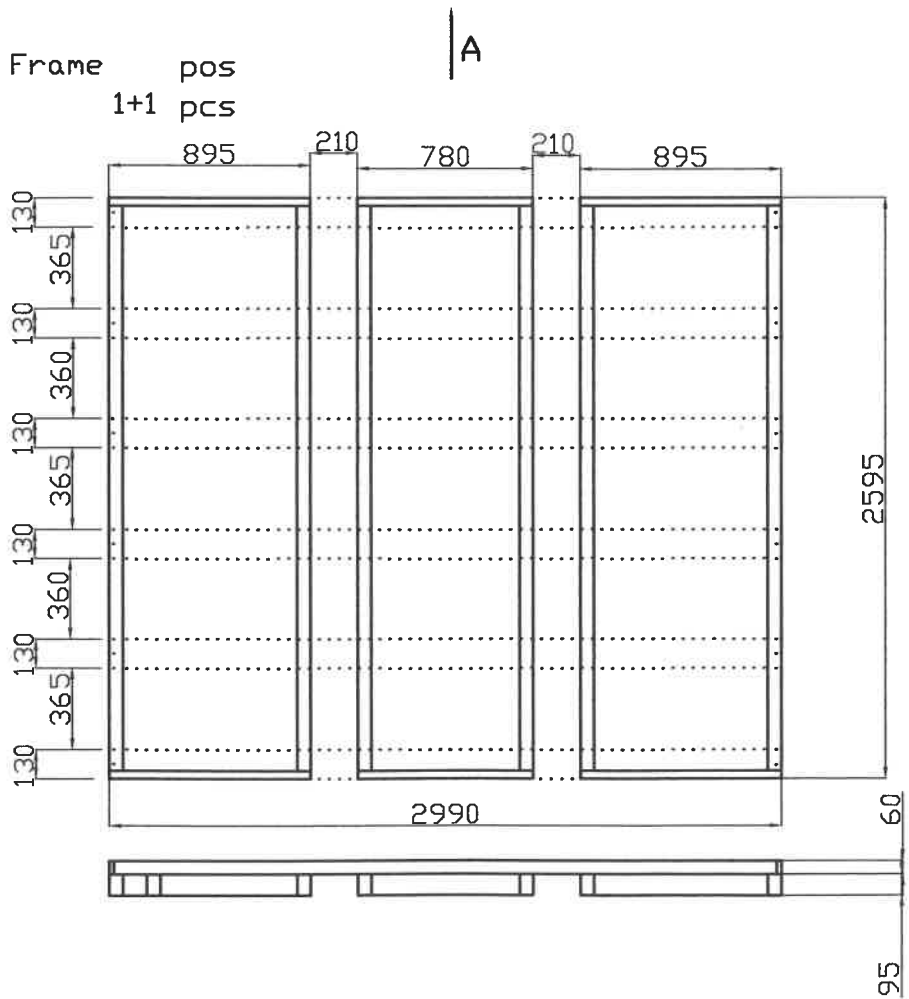
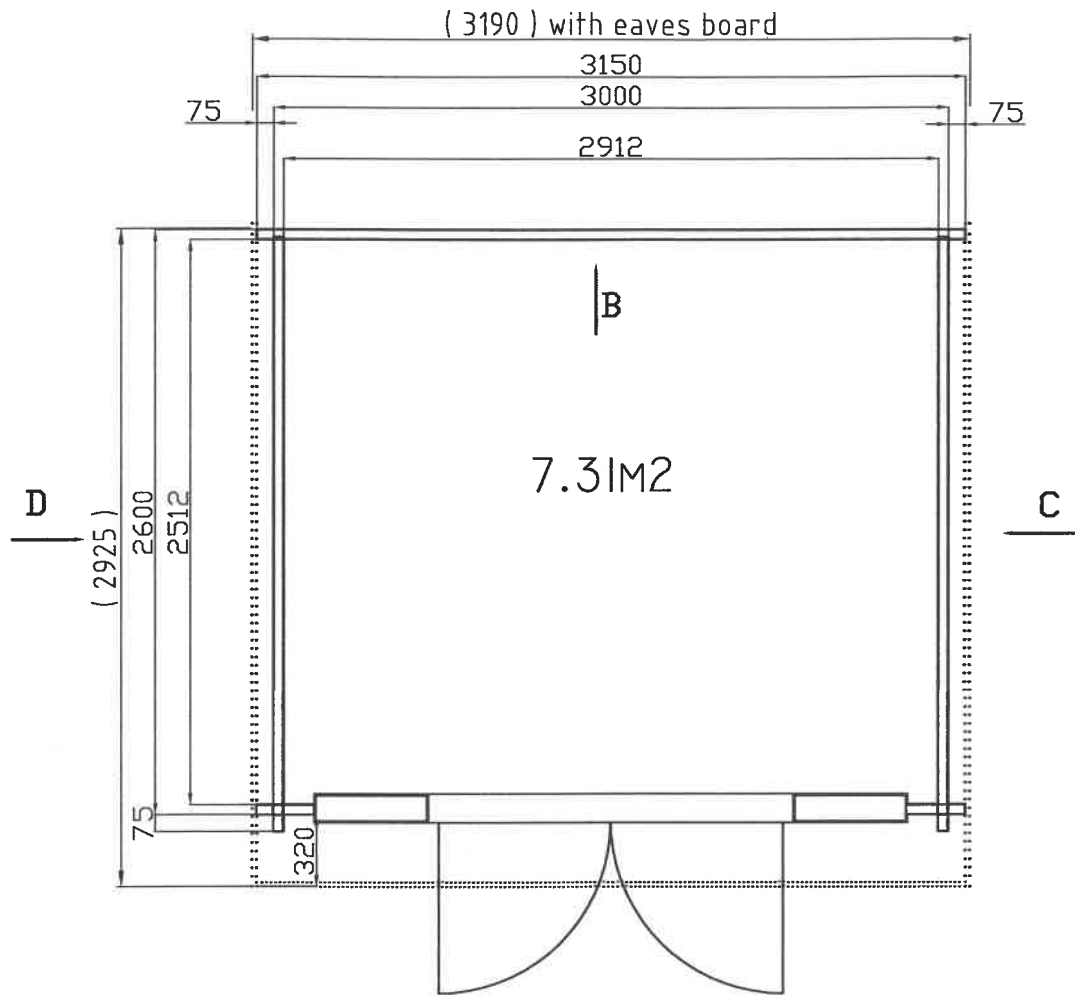
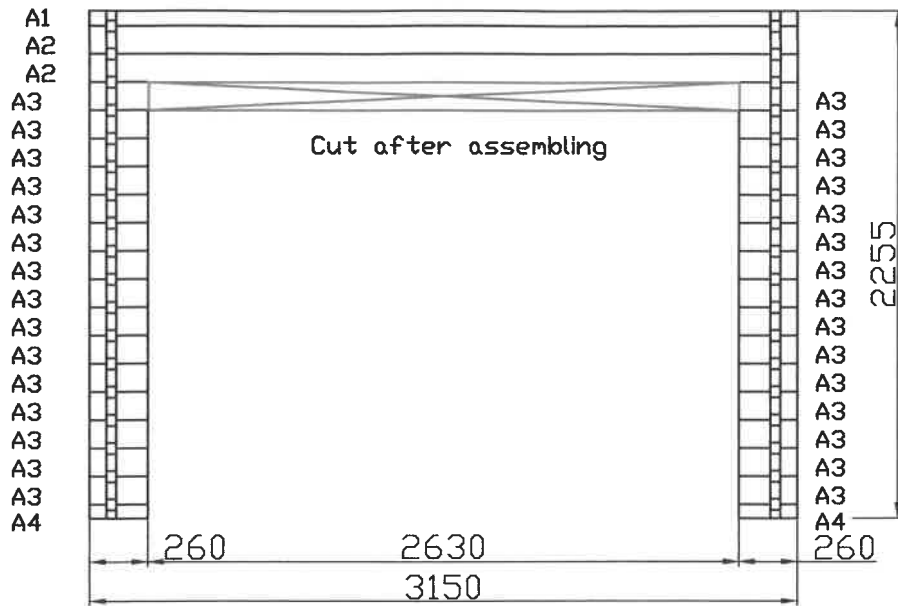

like A2 Cut after assembling

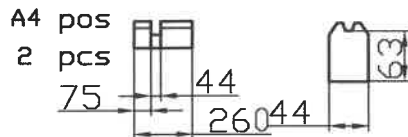
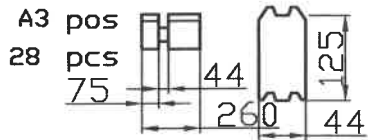
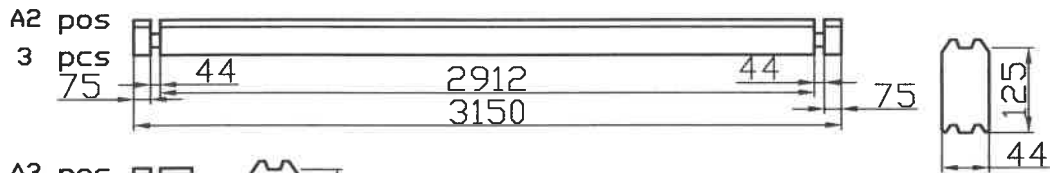
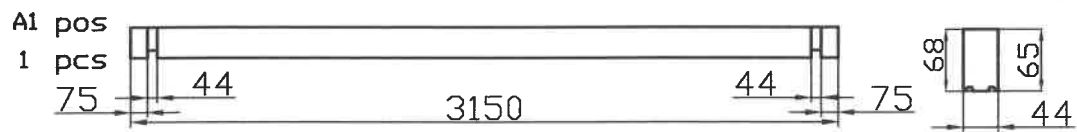

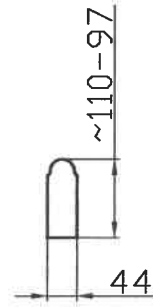
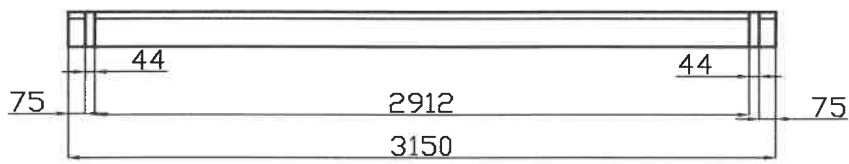
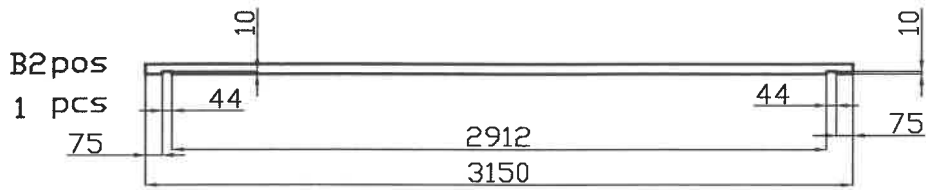
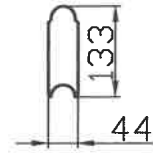
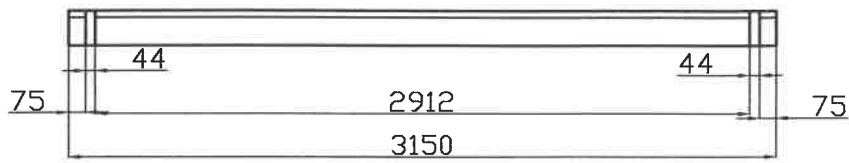
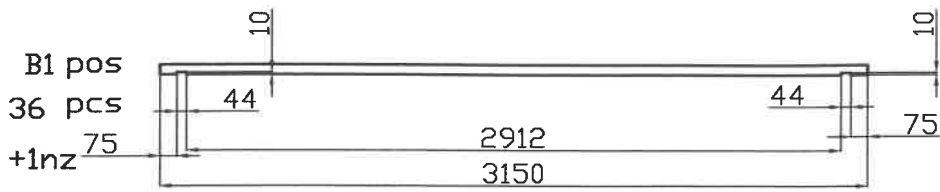

Like B1

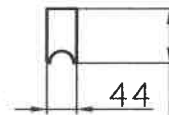
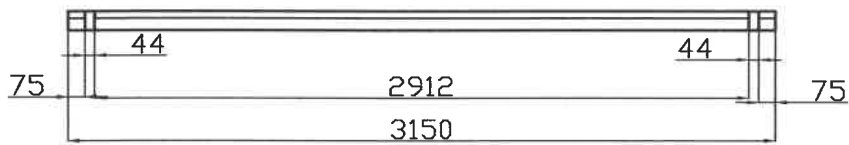
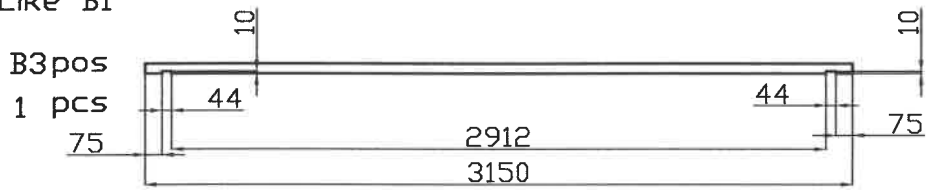

B1

B1

B1

B1

B1

B1

B2

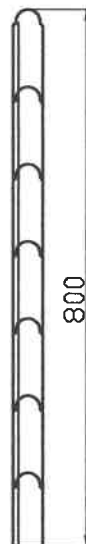

Cut after assembling

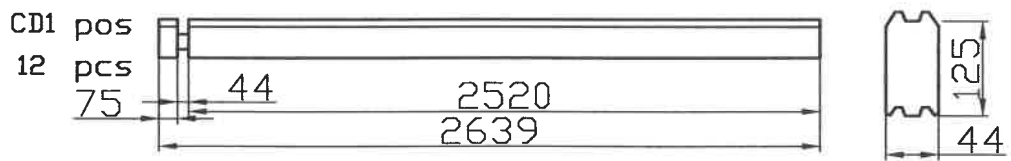
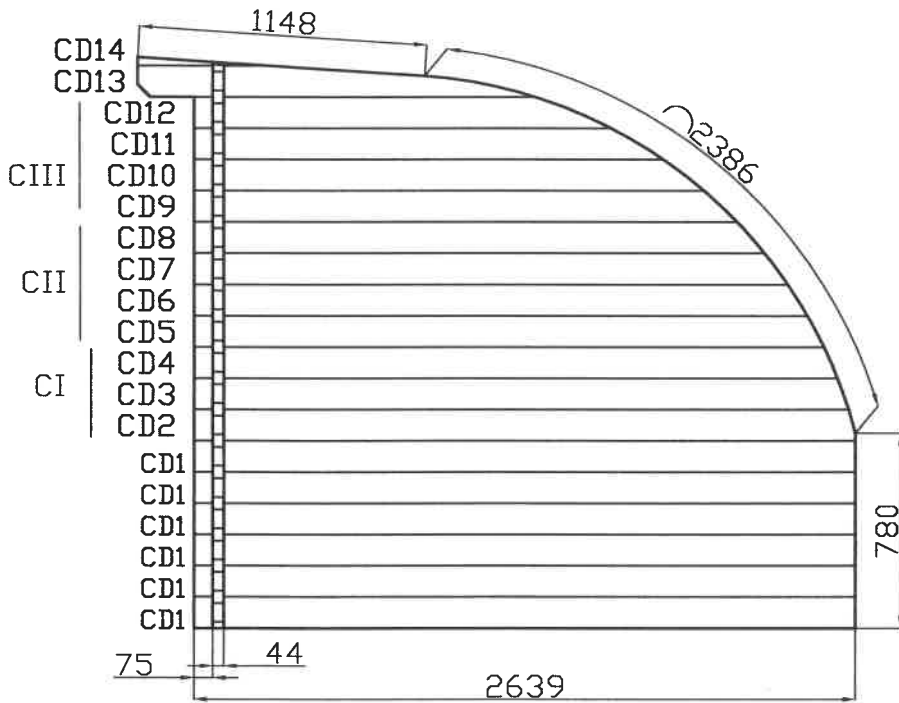
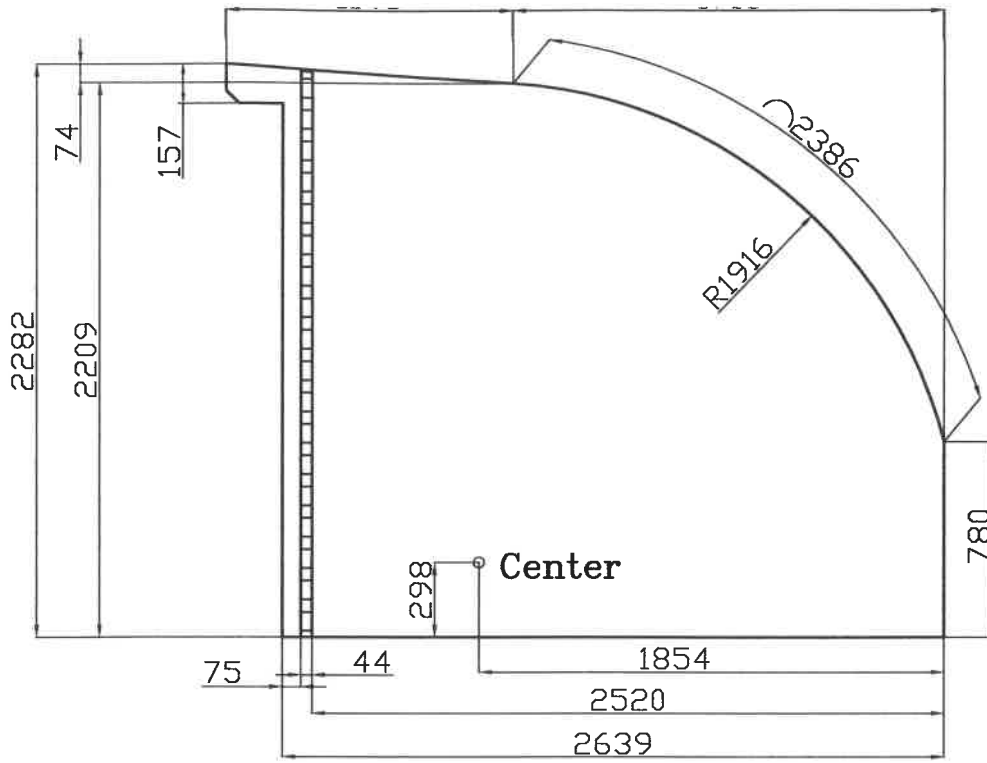

CD2 CD14 - like in drawing

Da1 3190*120*18-1pcs, 

Da2 3190*58*18-1pcs, 

Forehead board:

Da3-Da6 2pcs each 

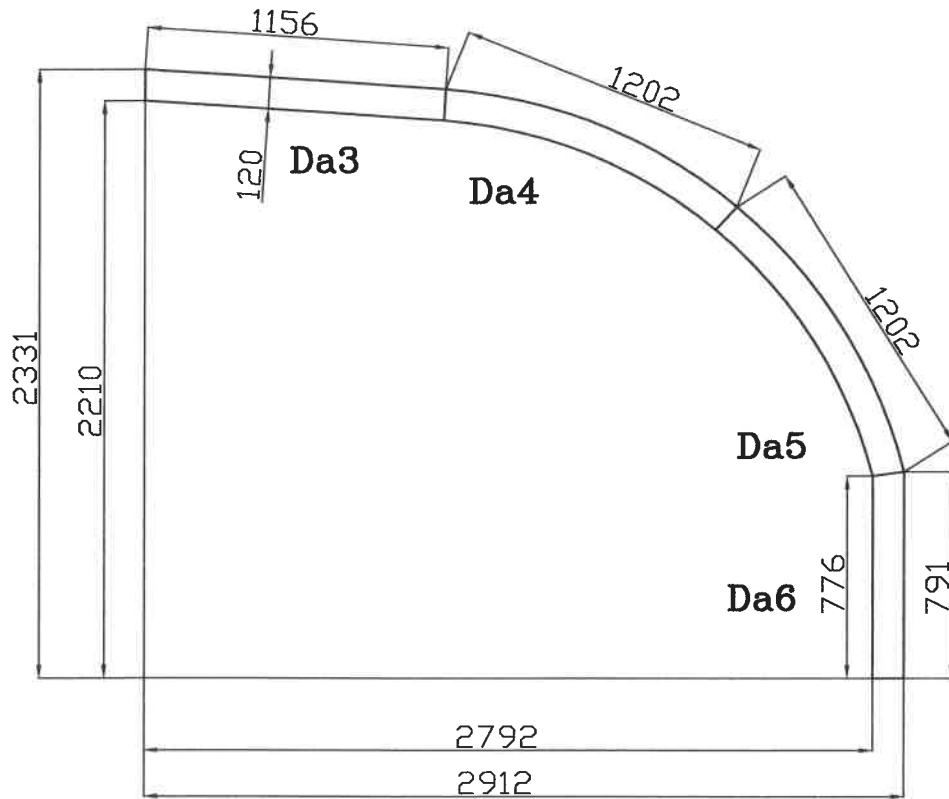

Da3
2vnt

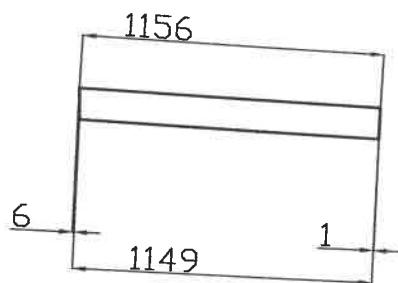

Da4
2vnt

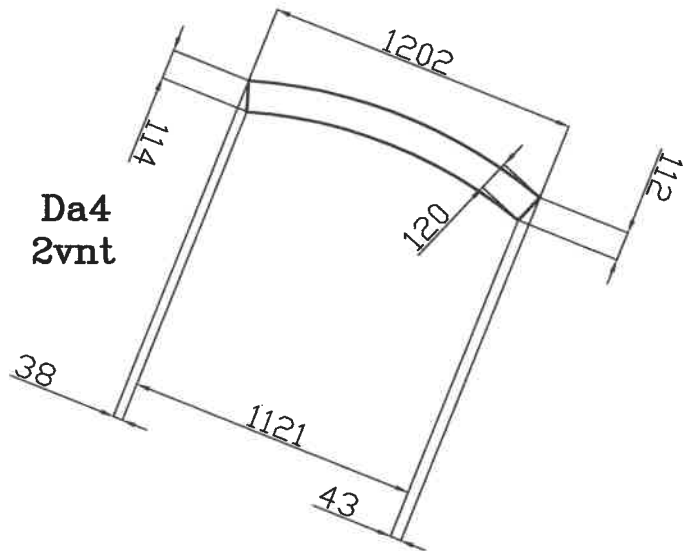

Da5

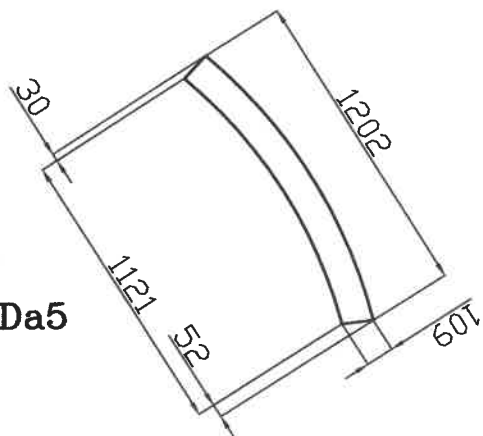

Da6

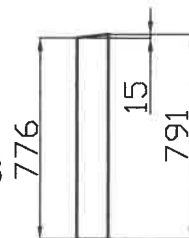

X1 Cover for top wall A: 2950*25*25 -2pcs 

T1 Double door with side panels: 2615*1930-1pcs.