

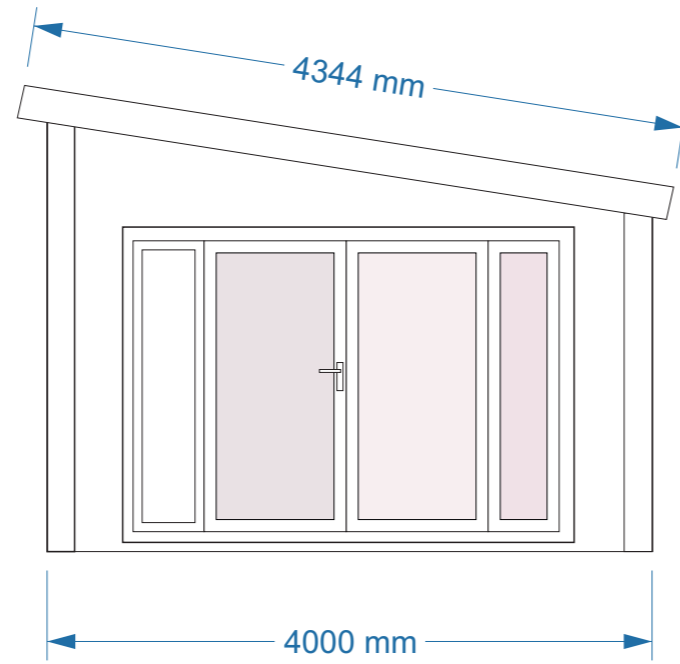

## SPECIFICATION

- Cedar exterior cladding
  - EPDM Firestone rubber roof covering
  - 24mm argon double glazed windows & doors
  - BS EN 1647 : 2012 Thermal Class 3
  - Painted and wheeled steel chassis
- 
- Brushed steel double sockets with usb where applicable
  - Low energy recessed led lights
  - Low energy exterior led lights
  - TV aerial socket/s
  - lpg combi Boiler and feature tall anthracite radiators
  - 2100mm kitchen with fridge, extractor, microwave, double socket, sink, LPG double hob and oven
  - Toilet, sink, mirror, shower, extractor & heated towel rail
  - Thermal Class 3





front

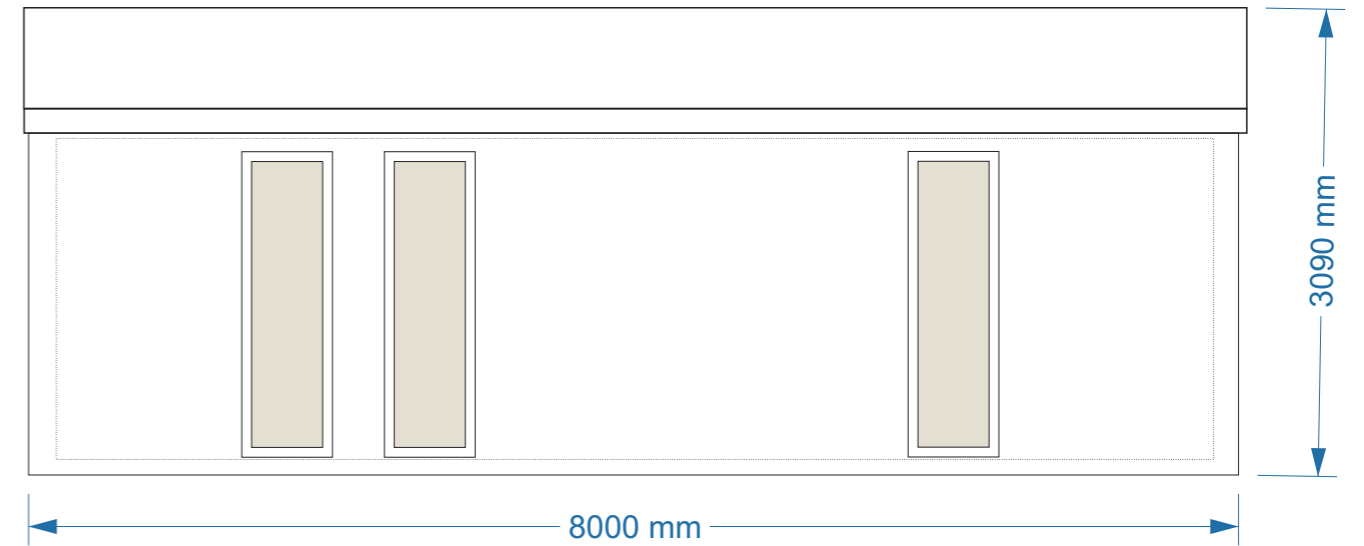

left elevation

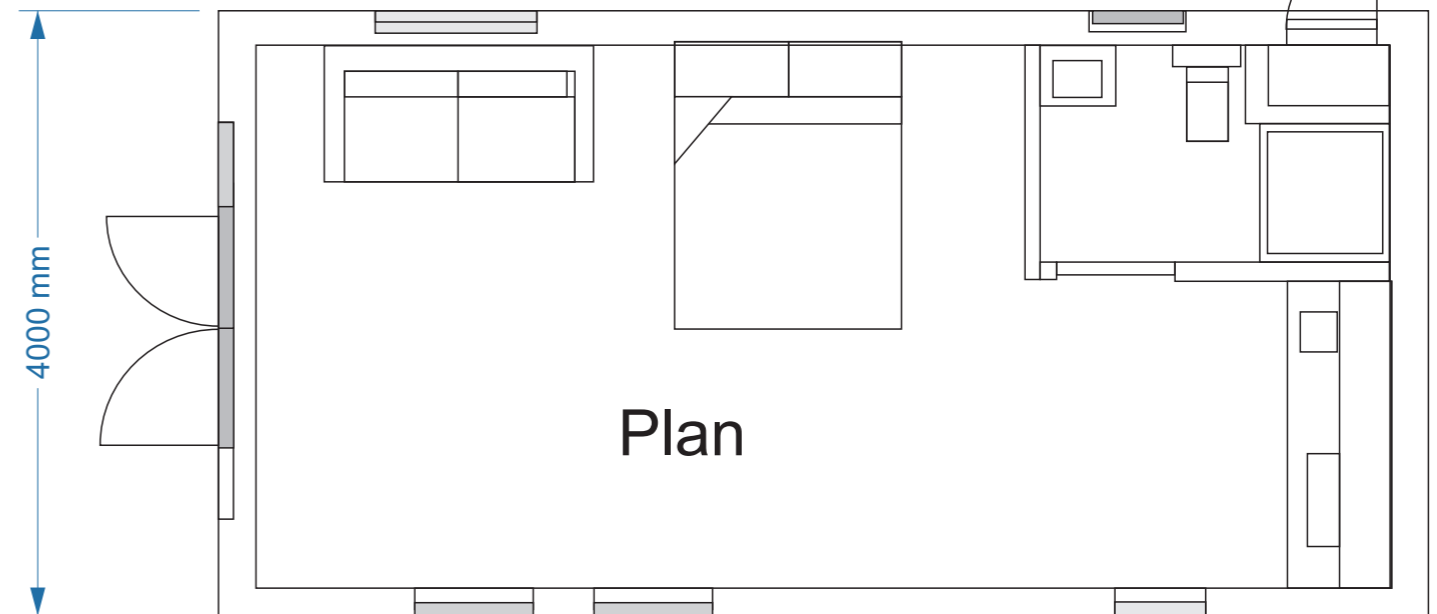

Plan



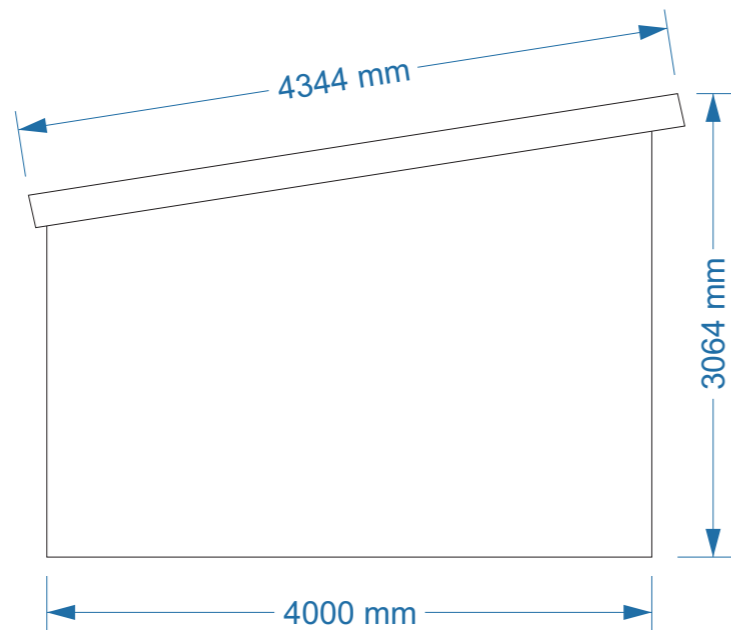

back elevation

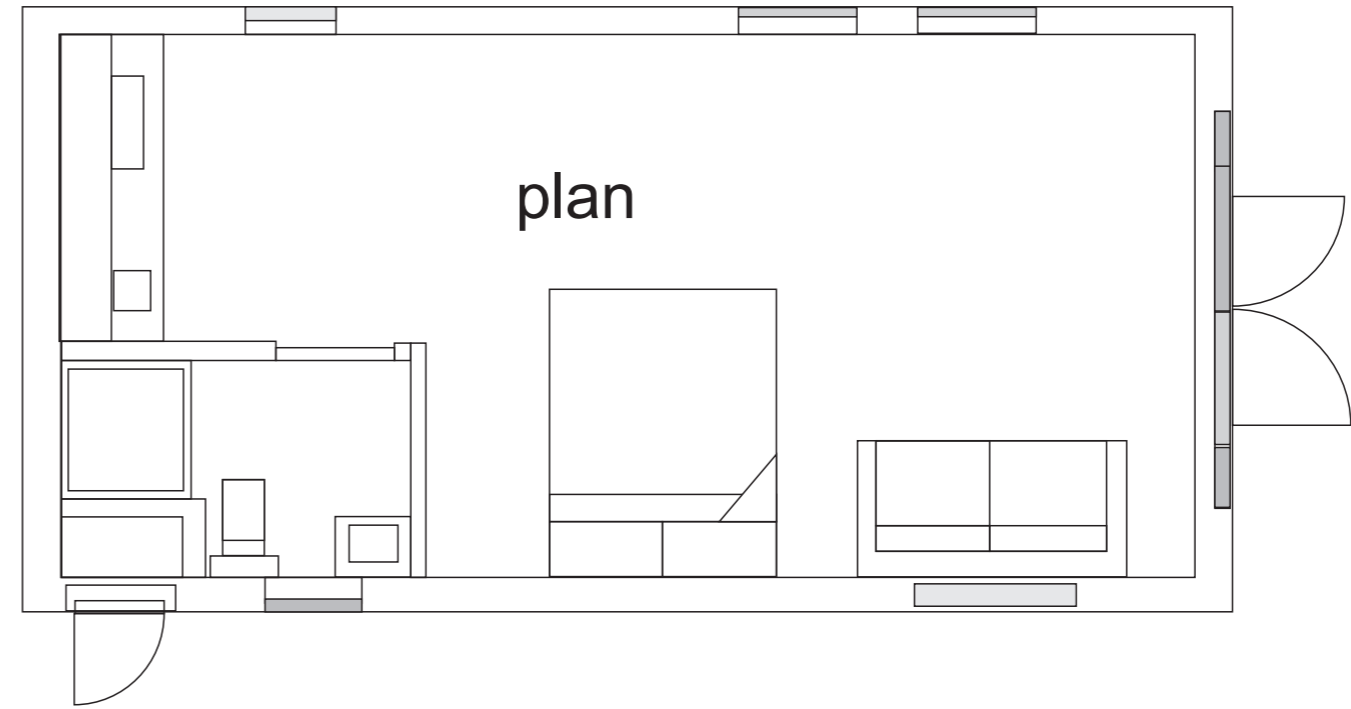

plan

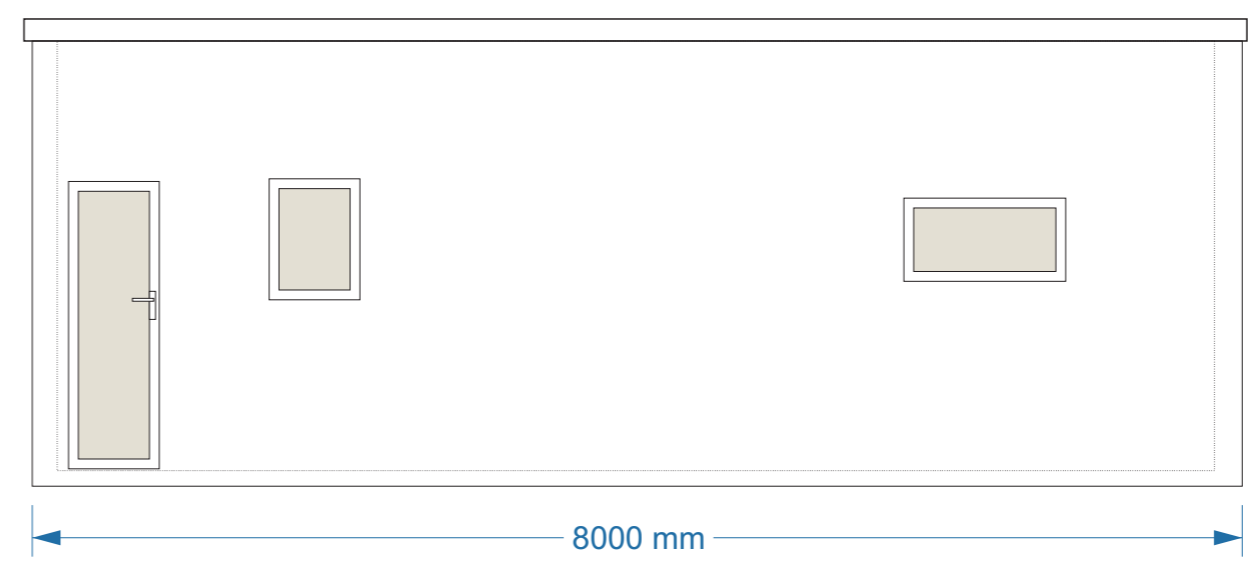

Right elevation



double door  
or bifold

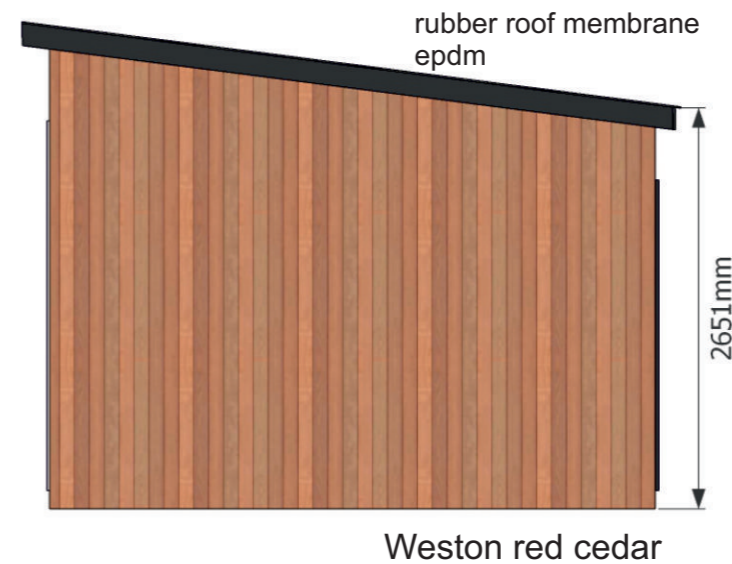
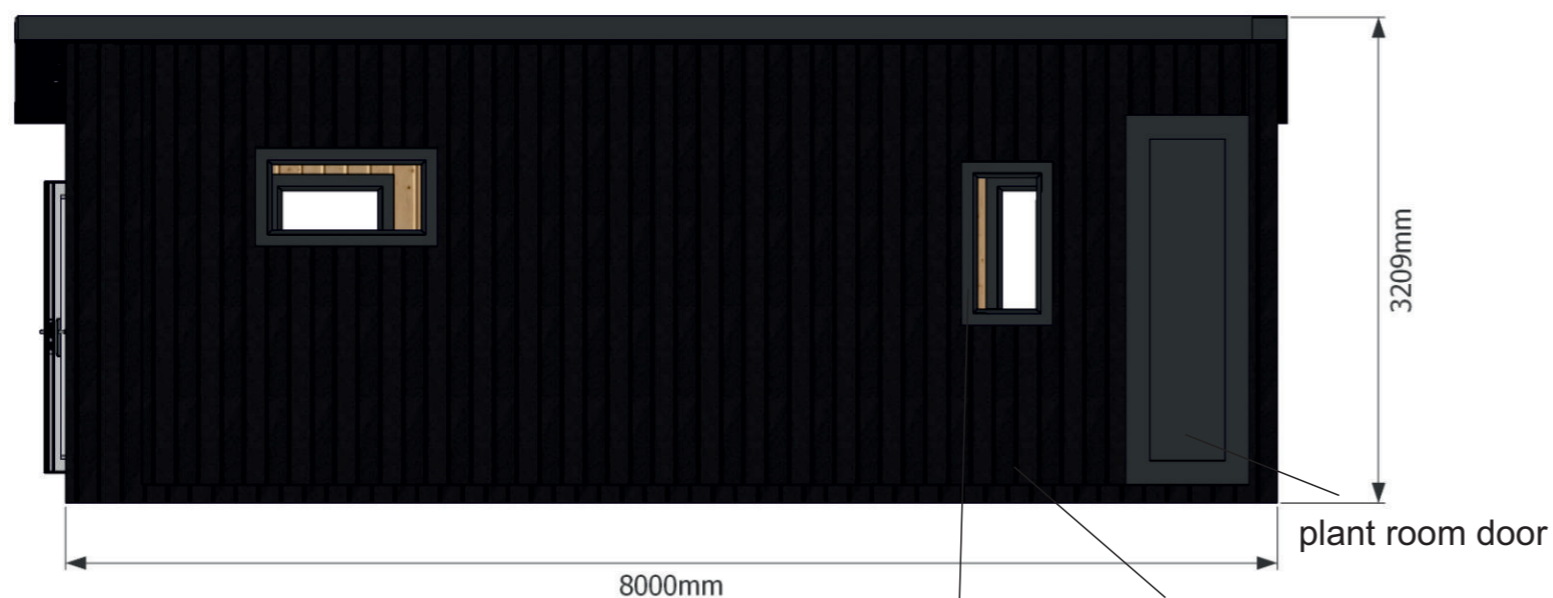

plant room door  
Stained Cedar  
other colour options  
bathroom privacy glass