



Report No: LTM0579.MS.01

Date: 28/09/2022

Project: Land at King Street, Longridge, Preston, PR3 3RQ

BS 5837:2012 Method Statement

Inspection Record.

Date of Inspection	Surveyor
08/07/2022	Matthew Lally. FdSc MArborA

Lally Tree Management.

36 Goldsworthy Road, Urmston, Manchester, M41 8US

[T] 07305 740120 [E] matt@lallytreemanagement.co.uk [W] <https://www.lallytreemanagement.co.uk/>

This report is the property of Lally Tree management. This report may only be reproduced or disclosed to third parties with express written consent from Lally Tree Management.

Revision	Date	Prepared by	Status
Final	28/09/2022	M. Lally	Final

Contents

1.0 Discussion	4
2.0 Method Statement	5
2.1 Tree Works	5
2.2 Protective Fencing	5
2.3 Additional Precautions Outside Fenced Areas	5
2.4 Cellular Confinement System.	6
2.5 Ground Protection (Special Measures)	6
2.6 Installation of Utilities	6
2.7 Pre-commencement Site meeting	7
2.8 Summary of Methodology for the Protection of the Trees	7
2.9 Site Briefing	7
Appendix One Tree Plan	
Appendix Two Tree Protection Fencing	
Appendix Three Special Measures Area	
Appendix Four Construction of Special Surfaces	
Appendix Five NJUG Vol 4	

1.0 Discussion

- 1.1 The majority of the root system of a tree is in the surface 600mm of the soil extending radially for distances frequently in excess of the trees height. Beyond the main structural roots (close to the base of the trunk), the root system rapidly sub-divides into smaller diameter roots: off this main system, a mass of fine roots develops.
- 1.2 The shape of the main structural roots develops in response to the need for the tree to have physical stability. Beyond these major roots, root growth and development is influenced by the availability of water and nutrients. Unless conditions are uniform around the tree, which would be unusual, the extent of the root system will be very irregular and difficult to predict. It will not generally show the symmetry seen in the branch system.
- 1.3 The parts of the root system, which are active in water and nutrient uptake, are very fine, typically less than 0.5mm diameter. They are short lived, developing in response to the needs of the tree, with the majority dying each winter. It is *essential* that conditions in the soil remain conducive to the healthy growth of these fine roots so that the water and nutrients necessary for healthy tree growth can be absorbed.
- 1.4 All parts of the root system, but especially the fine roots, are vulnerable to damage. Once they are damaged, water and nutrient uptake will be restricted until new roots have regenerated. Vigorous young trees will be capable of rapid regeneration, but over mature trees will respond slowly, *if at all*.
- 1.5 In order to live and grow, roots need oxygen from the soil. Respiration by the roots and other soil organisms depletes this oxygen and increases carbon dioxide levels in the soil; a correct balance of these gases is normally maintained by diffusion between the soil and the atmosphere. Anything, which disturbs this balance, will affect the condition of the root system.
- 1.6 The factors that most commonly affect this diffusion adversely, and therefore damage roots, are the following: -
 - a) Compaction of the ground, which reduces the space between soil particles. This is particularly important on clay soils. A single passage by heavy equipment on clay soils or storage of heavy materials can cause significant damage.
 - b) Changing soil levels, even for a few weeks.
 - c) Covering the root area with impervious surfaces.
 - d) A rise in the level of the water table. Roots can tolerate submersion for short periods. But a permanent rise will deplete the soil of oxygen.
- 1.7 Serious damage is often caused during preliminary site works by stripping the topsoil. For this reason, such works should be avoided until protective fencing has been erected.
- 1.8 Excavations in the rooting area can sever roots. As the majority of roots are in the surface 600mm, even shallow excavations can cause damage.
- 1.9 Excavations for foundations, landscaping or service trenches are usually sufficiently deep to sever most of the roots, and it should therefore be assumed that all parts of the root system beyond the excavation would no longer serve the tree.

- 1.10 Excavation or soil stripping which sever or damage the roots may impair the stability of the tree and make it dangerous.

2.0 Method Statement

Before any form of development commences on the site the following works should be undertaken: -

2.1 Tree Works

Tree No.	Species	Proposed Works to Facilitate Development.
T1	Birch	No Action
T2	Birch	No Action
T3#	Willow	Remove
G4#	Rowan x 2	Remove

All works to be undertake in line with BS 3998:2010. Tree Work. Recommendations

2.2 Protective Fencing

- 2.2.1 All fencing used on the site should fully comply with BS 5837:2012 (Trees in Relation to Construction – Recommendations).
- 2.2.2 The fencing should be strong and suitable for local conditions. It should also take into account the degree of construction activity on the site.
- 2.2.3 The fencing should be at least 2.3m in height and should be erected with both a vertical and horizontal scaffolding framework capable of withstanding impact, with vertical tubes spaced at a maximum of 3 m. This should support weldmesh panels which should be securely fixed with wire or scaffold clamps.
- 2.2.4 Notices should also be erected on the fencing stating, 'Protected Area - No operations within fenced area'.
- 2.2.5 The positioning of the protective fencing is also very important and should be erected in the proposed location identified in Appendix One. Once the fence has been erected it should never be crossed and particular care should be taken not to store any materials or soil within the protected area.

2.3 Additional Precautions Outside Fenced Areas

- 2.3.1 Oil, bitumen, cement or other material likely to cause damage to the tree will not be stacked or discharged within 10m of the trees stem or within the protective area. Also, materials in general will not be stacked or discharged within the exclusion zone.
- 2.3.2 Concrete mixing and washing will not be carried out within 10m of any retained trees.

- 2.3.3 Fires will not be lit beneath the foliage or in a position where the flames could extend to within 5m of the foliage, branches or trunk. If the fire is large, then this may necessitate a distance of at least 20m.
- 2.3.4 Trees that are to be retained will not be used as anchorage for equipment.
- 2.3.5 Notice boards, telephone cables, or other services will not be attached to any part of the retained tree.
- 2.3.6 Care should be taken when using cranes or other equipment near the canopy of the retained trees. Also, any trees to be felled in proximity to the retained trees should be done so with particular care.

2.4 Cellular Confinement System

- 2.4.1 The use of a cellular confinement system will be employed to create a drive that encroaches into the RPAs of T1 & T2 without having a detrimental effect.
- 2.4.2 A cellular confinement system provides a load transfer mattress which prevents direct loads on tree roots and reduces the bearing pressure on subsoil's by stabilising aggregate surfaces against rutting under wheel loads.
- 2.4.3 A proposed methodology and cross-sectional diagram for the construction of the access way can be found in appendix four.

2.5 Ground Protection (Special Measures)

- 2.5.1 The dimensions of the ground protection is outlined in appendix one, with a possible design shown in appendix three of this document.
- 2.5.2 For the use of pedestrian-operated plant up to a gross weight of 2 t, interlinked ground protection boards placed on top of a compression-resistant layer (e.g. 150 mm depth of woodchip), laid onto a geotextile membrane can be used as ground protection. Heavier plant will require an engineered design solution based on an arboriculturalist advice.

2.6 Installation of Utilities

- 2.6.1 The installation of any utilities will be undertaken in line with NJUG Volume 4. 'Guidelines for the planning, installation and maintenance of utility apparatus in proximity to trees' Excavation using the methodology outlined in NJUG Vol.4 will not affect the safe useful life of the aforementioned trees.
- 2.6.2 A copy of NJUG Vol 4 has been made available in appendix five.

2.7 Pre-commencement Site meeting

2.7.1 Prior to commencement of site works, a meeting onsite must take place including the site manager and an arboricultural consultant. This meeting will allow further discussion of the programme of works, tree protective measures, locations of areas for storage/site organisation and the agreement of any changes to the method statement that may be required which will be formally updated and approved as required.

2.8 Summary of Methodology for the Protection of the Trees

- 1) Pre commencement site meeting
- 2) Tree removal
- 3) Site briefing for personnel
- 4) Installation of protective fencing and ground protection
- 5) Installation of cellular confinement system
- 6) Implementation of development and installation
- 7) Completion of development works
- 8) Completion signed off
- 9) Removal of protective fencing & any ground protection
- 10) Soft landscaping works

2.9 Site Briefing

2.9.1 The site manager is responsible for ensuring that all personnel are made fully aware of the constraints posed by the retained trees on site and that there are measures in place to protect these trees, this includes having full access to the Arboricultural Method Statement and Tree Protection plan (TPP).

Appendix One

Tree Plan



Do not scale this drawing (printed or electronic version).
 Contractors must check all dimensions from site.
 This drawing is for use on this site only and should be used in conjunction with all relevant consultants drawings.

LEGEND



- Retained Trees
- Removed Trees
- Root Protection Areas
- Protective Fencing (Metal)
- Ground Protection
- Cellular Confinement System
- #** Position estimated on site

DIXON ROAD

27

T3#

T2

T1

G4#

2 no. existing small trees (G4) to be removed

Existing redundant WC building to be demolished shown dashed (orange)

PROPOSED NEW SINGLE STOREY DWELLING

Indicative area of recessed photovoltaic (solar) panels on the south-west facing roof slope. Exact system size/ specification to be confirmed.

Garden

Bin storage area

Permeable Block

Existing BT pole to be retained and protected throughout the course of the construction works

Existing overgrown shrubs/ planting to be removed

Coursed natural stone wall re-built over existing low-level (boundary) retaining wall



Scale: 1:100@A2	Date: 28/09/2022
Job: LTM0579.AIA.01	
Address: King Street, Longridge, Preston	
Client: Monks Architectural Design	
Drawing Number: LTM0579.TPP.01	
Drawn by: Matthew Lally	

TREE PROTECTION PLAN

Appendix Two

Tree Protection Fencing



Tree Protection Fencing (BS5837: 2012)

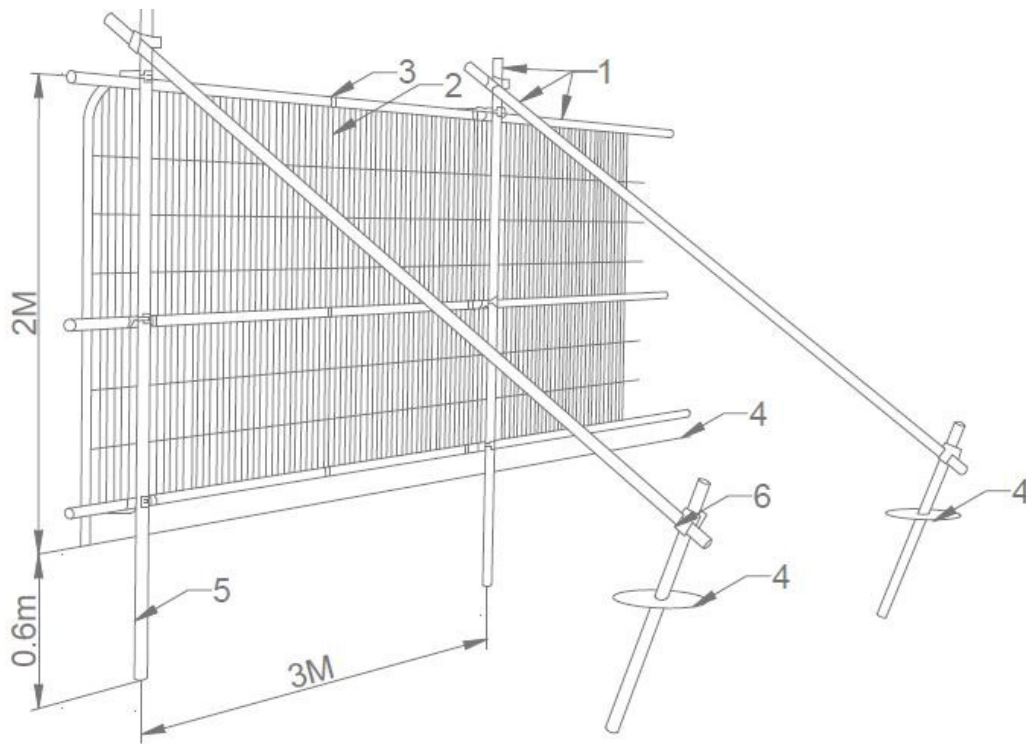

Key

- 1 Standard scaffold poles
- 2 Heavy gauge 2m tall galvanised tube and welded mesh infill panels
- 3 Panels secured to upright and cross-members with wire ties
- 4 Ground level
- 5 Uprights driven into the ground until secure (minimum depth 0.6m)
- 6 Standard scaffold clamps

Protective fencing Notice to attached to fencing

	
<p>PROTECTIVE FENCING. THIS FENCING MUST BE MAINTAINED IN ACCORDANCE WITH THE APPROVED PLANS AND DRAWINGS FOR THIS DEVELOPMENT.</p>	<p>TREE PROTECTION AREA KEEP OUT !</p> <p><small>(TOWN & COUNTRY PLANNING ACT 1990) TREES ENCLOSED BY THIS FENCE ARE PROTECTED BY PLANNING CONDITIONS AND/OR ARE THE SUBJECTS OF A TREE PRESERVATION ORDER. CONTRAVENTION OF A TREE PRESERVATION ORDER MAY LEAD TO CRIMINAL PROSECUTION</small></p> <p><small>ANY INCURSION INTO THE PROTECTED AREA MUST BE WITH THE WRITTEN PERMISSION OF THE LOCAL PLANNING AUTHORITY</small></p>

Appendix Three

Special Measures Area

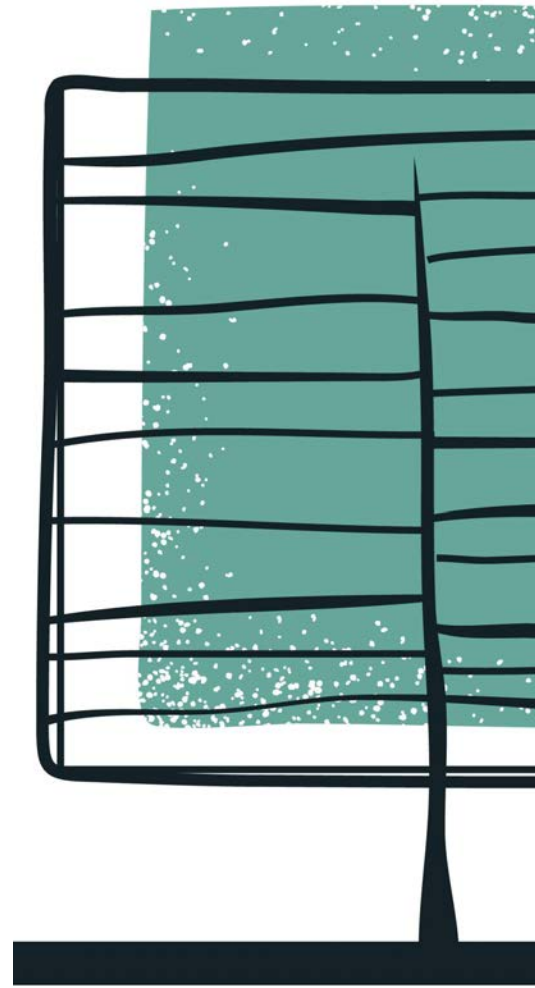

Special Measures Area (pedestrian)

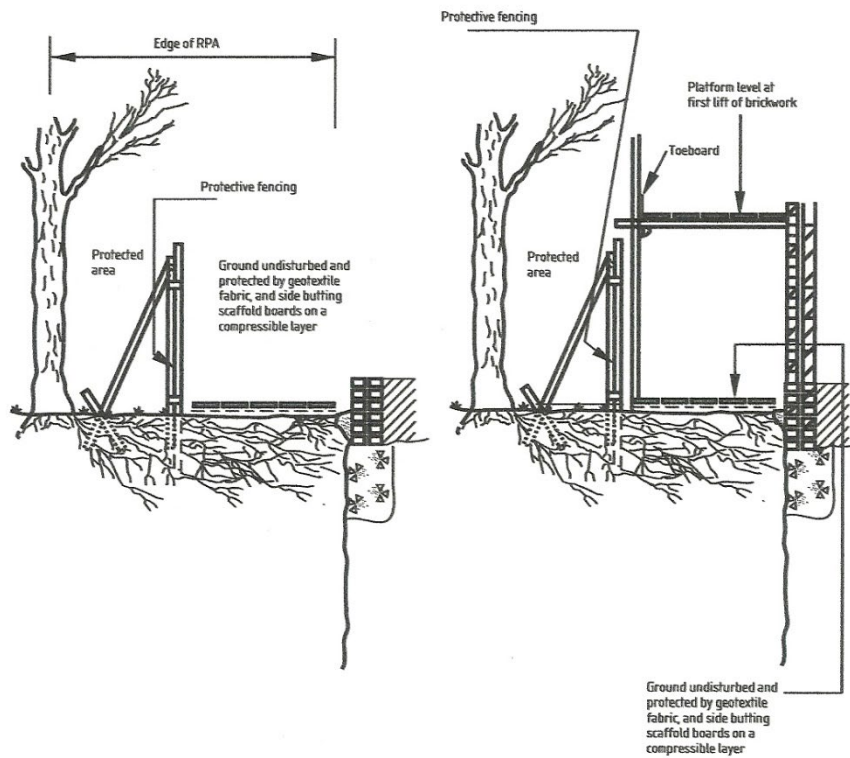

Ground protection and scaffolding within the RPA (taken from BS5837:2005)

Interlinked plastic boards with a layer of chip can be used as ground protection.

The below picture courtesy of Ground Guards (<http://www.ground-guards.co.uk/solutions/tree-root-protection/>) illustrates a possible method.



Appendix Four

Construction of Special Surfaces



METHODOLOGY FOR THE CONSTRUCTION OF HARDSTANDING AREAS WITHIN RPA OF RETAINED TREES

The following methodology supports the drawing indicating the construction of the hardstanding. The methodology is prepared on the basis of the sequence of operations necessary to complete the hardstanding with the minimum damage to the trees proposed for retention.

- Surface layer to be scraped off. This can be done either by hand or by very small machinery.
- Erect protective fencing to the edge of the construction area.
- Spread a sub grade material over the length of the hardstanding to fill any small ruts.
- Construct edging using treated timber if required.
- Lay geotextile mat over smoothed area.
- Extend the Geoweb perforated tree root protection system over the area of the hardstanding with sufficient overlap such that kerbs can be constructed on top of the Geoweb.
- Fill the voids within the Geoweb with reduced fines Type 1 material working into the site over the top of the Geoweb.
- Lay kerbs and surface over the Geoweb such that the construction binds itself together.
- Construct finished surface as required in line with guidance illustrations below.

GEOWEB BASED CONSTRUCTION – (INDICATIVE ONLY)

Depth of confinement system variable according to use- refer to manufacturer

Tarmac Surface

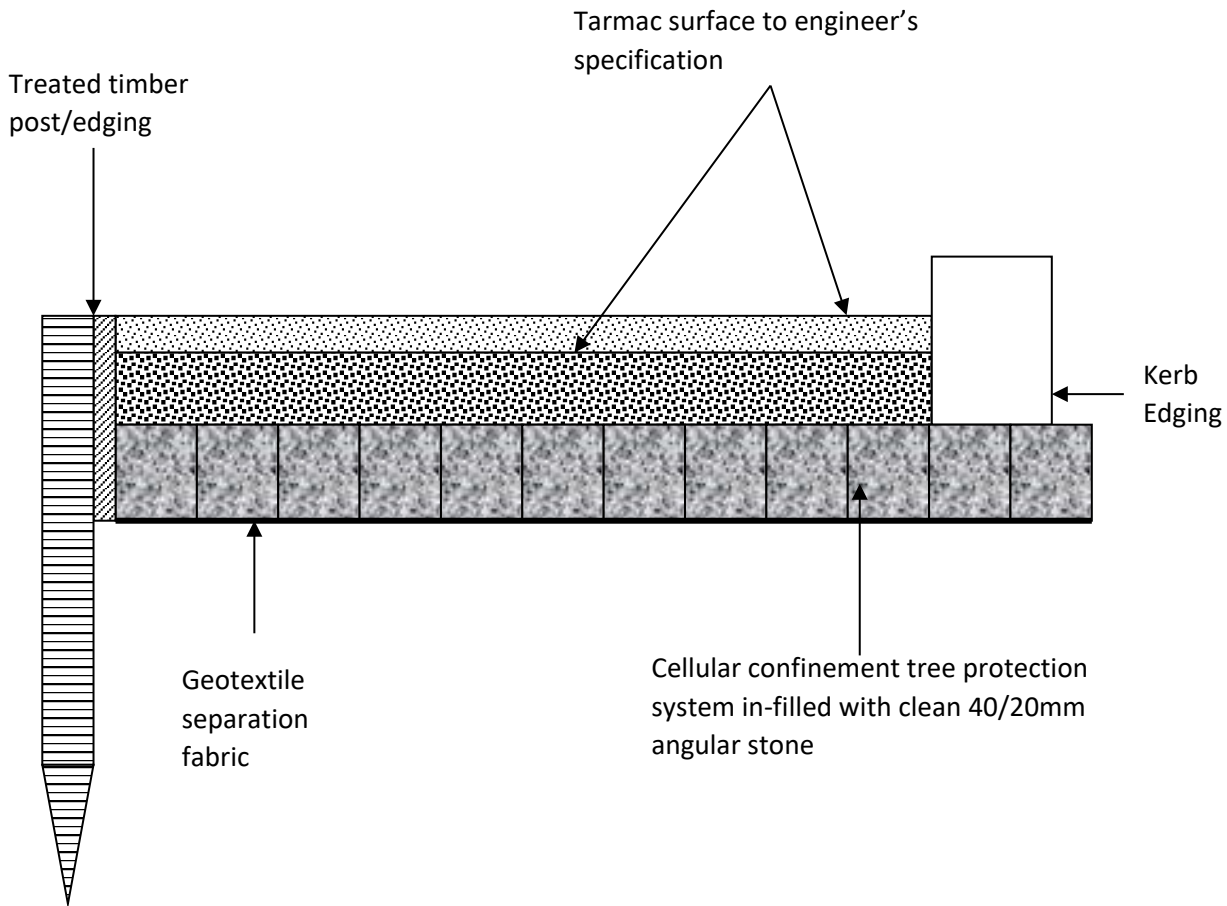

Block Paved Surface

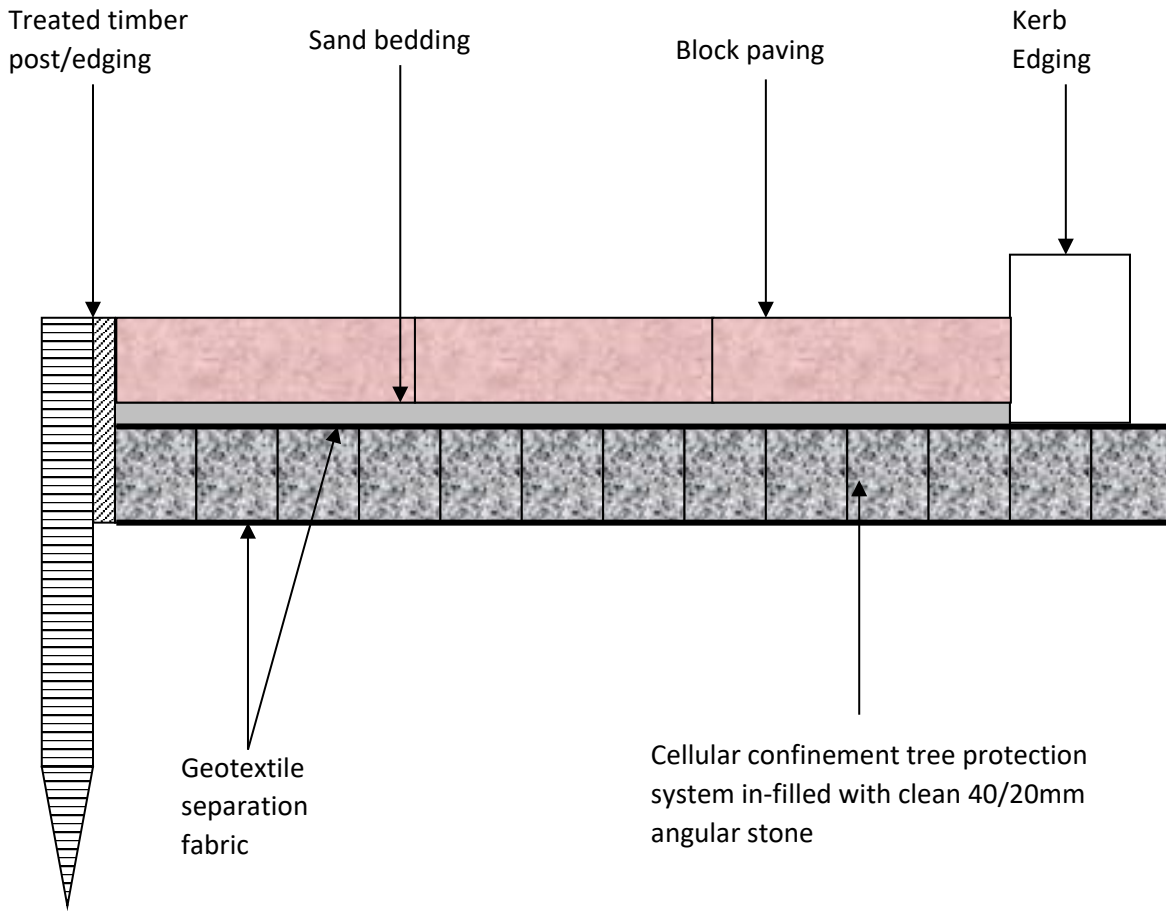

Gravel Surface

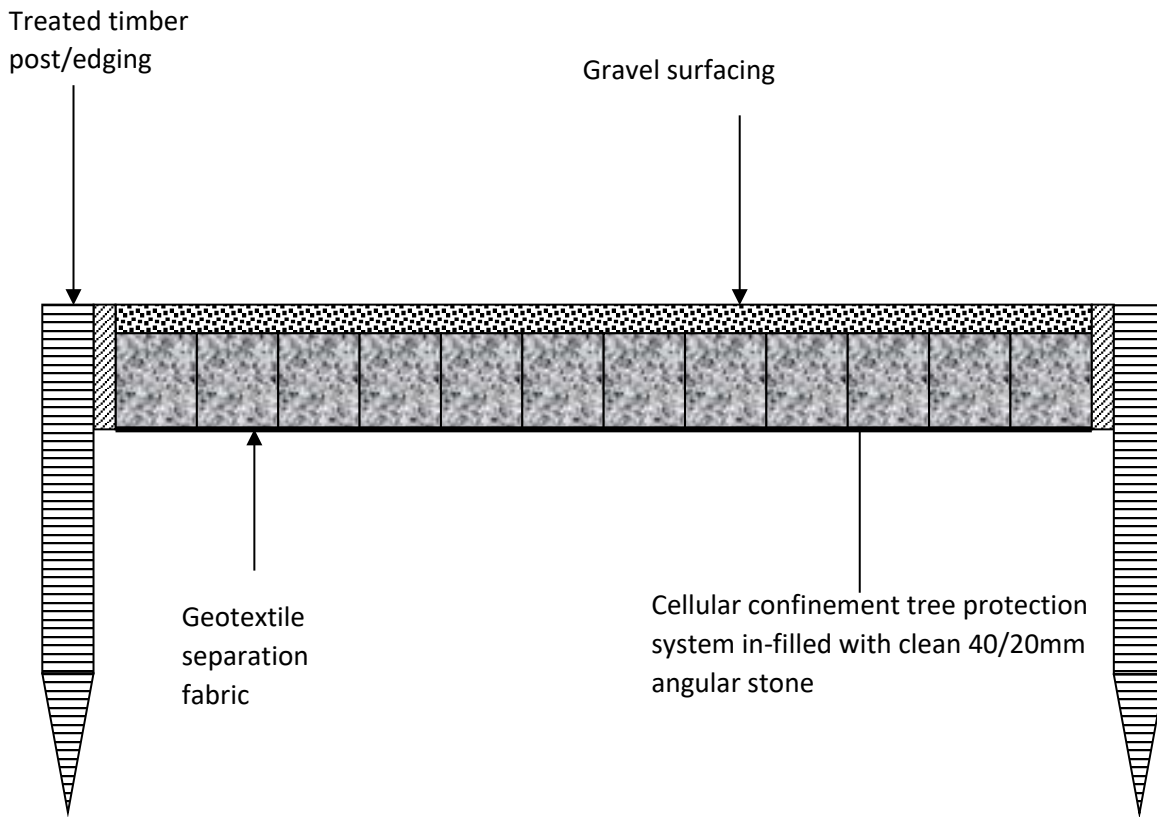

Appendix Five

NJUG Vol 4



NJUG Guidelines for the Planning, Installation and Maintenance of Utility Apparatus in Proximity to Trees

Volume 4

NJUG GUIDELINES FOR THE PLANNING, INSTALLATION AND MAINTENANCE OF UTILITY APPARATUS IN PROXIMITY TO TREES

PLEASE ENSURE THAT YOU READ THE LEGAL NOTICE AND DISCLAIMER WHICH APPEARS IN APPENDIX B OF THIS PUBLICATION

Issue 2: 16th November 2007

NJUG has a vision for street works, this vision is simply:

- **Safety is the number one priority**
- **Damage to underground assets is avoided**
- **Utilities work together and in partnership with local authorities to minimise disruption**
- **Utilities deliver consistent high quality**
- **Utilities maximise the use of sustainable methods and materials**
- **Street Works in the U.K. are regarded as world class**

This document forms part of that vision.

**Mark Ostheimer
Director, Safety and Policy**

NJUG Guidelines for the Planning, Installation and Maintenance of Utility Apparatus in Proximity to Trees

The following volumes constitute the NJUG Publications. They are living documents and may be amended from time to time. There is no attempt to describe any specific industry process as each utility has its own specifications and procedures. Not all the publications will necessarily be available at one time as individual volumes will be published when available.

NJUG PUBLICATIONS	
<i>Current</i>	<i>Previous</i>
VOLUME 1	
NJUG Guidelines on the Positioning and Colour Coding of Underground Utilities' Apparatus	NJUG 4 & 7
VOLUME 2	
NJUG Guidelines on the Positioning of Underground Utilities Apparatus for New Development Sites	NJUG 2, 5 & 6
VOLUME 3	
NJUG Guidelines on the Management of Third Party Cable Ducting	New
VOLUME 4	
NJUG Guidelines for the Planning, Installation and Maintenance of Utility Apparatus in Proximity to Trees	NJUG 10
VOLUME 5	
NJUG Guidelines on Environmental Good Practice	New
VOLUME 6	
Legislation & Bibliography	NJUG 1

The following NJUG publications have not been reviewed and have been completely withdrawn:

- NJUG 3 – Cable Locating Devices
- NJUG 8 – Performance Guide for the Assessment of Metallic Pipe and Cable Locators
- NJUG 9 – Recommendations for the Exchange of Records of Apparatus between Utilities
- NJUG 11 – Proposed Data Exchange Format for Utility Map Data
- NJUG 12 – NJUG Specification for the Digitisation of Large Scale OS Maps
- NJUG 13 – Quality Control Procedure for Large Scale OS Maps Digitised to OS 1988
- NJUG 15 – NJUG/Ordnance Survey Service Level Agreement (Technical) for Digital Map Products and Services

NJUG Guidelines for the Planning, Installation and Maintenance of Utility Apparatus in Proximity to Trees

CONTENTS

Background	5
Scope	5
1. HOW TREES ARE DAMAGED	7
1.1 The Root System	7
1.2 Below Ground	10
1.3 Above Ground	13
2. HOW APPARATUS IS DAMAGED	14
2.1 Below Ground	14
2.2 Above Ground	16
3. PLANNING OF WORKS	16
3.1 Special Considerations when Planning the Installation of Underground Apparatus	16
3.2 Precautions when Repairing Existing Apparatus	17
3.3 Special Considerations when Planning the Installation of Above Ground Apparatus	18
4. HOW TO AVOID DAMAGE TO TREES	19
4.1 Below Ground	19
4.2 Above Ground	24
4.3 Chemical Damage to Trees	26
5. HOW TO AVOID DAMAGE TO APPARATUS BY TREES	26
5.1 Consultation with Utilities	26
5.2 Precautions during Planting	26
6. SITES WITH DESIGNATED STATUS	27
6.1 Tree Preservation Orders and Trees in Conservation Areas	28

NJUG Guidelines for the Planning, Installation and Maintenance of Utility Apparatus in Proximity to Trees

7. LEGISLATION	28
7.1 Primary Legislation	28
7.2 Secondary Legislation	29
8. OTHER USEFUL PUBLICATIONS	29
9. OTHER REFERENCES	30
9.1 Arboricultural	30
9.2 Herbicides	30
9.3 Utilities	30
FIGURE 1 – Tree Protection Zone	9
FIGURE 2 – Typical Tree Structure	12
TABLE 1 – Prevention of Damage to Trees Below Ground	23
TABLE 2 – Prevention of Damage to Trees Above Ground	25
GLOSSARY	31
APPENDIX A	
Important Legal Notice and Disclaimer	33

In this document the word ‘apparatus’ is used to describe both the distribution mains and also the lateral apparatus to properties. The words ‘plant’ or ‘services’ are also used to collectively describe this and other equipment.

NJUG Guidelines for the Planning, Installation and Maintenance of Utility Apparatus in Proximity to Trees

This volume supersedes NJUG 10 'Guidelines for the Planning, Installation and Maintenance of Utility Services in Proximity to Trees' and has been drafted by NJUG members and arboriculturists.

Background

The statutory right of undertakers (utilities) to carry out works within the public highway in order to provide and maintain their apparatus dates from the mid - 19th century. There are no statutory obligations governing the position or depth at which apparatus should be laid within the highway. The following guidelines should therefore be adhered to wherever practicable.

The New Roads and Street Works Act 1991, as amended by the Transport Act 2000, the Traffic Management Act 2004, the Transport (Scotland) Act 2005 together with the Street Works (Northern Ireland) Order 1995, sets down the legislative requirements to be adopted during the installation, repair and maintenance of apparatus in roads and streets (**see Volume 6 – 'Legislation and Bibliography'**).

Scope

(i) Trees (including shrubs and hedges) play an essential role in the environment and visual amenity of both rural and urban landscapes. They may take decades to grow, but can be destroyed in minutes. Wherever they are growing, whether in public footpaths, private gardens, rural verges or elsewhere, they require space for the adequate development of their root systems and to allow the branches to develop an attractive and natural shape.

(ii) Modern society expects a multiplicity of apparatus (electricity, gas, water, sewage, telecommunications and cable television) each of which requires an extensive distribution network, both above and below ground. These networks also need space, and they are frequently under tight constraints regarding their alignment.

(iii) The space available for both trees and apparatus is often very restricted, and they are frequently forced to share the available space, both above and below ground. Where they are in close proximity, there is the potential for either the tree or the apparatus to be subject to damage. To successfully co-exist precautions should be taken to minimise the risk of damage to both trees and apparatus based upon technical guidance obtained from this document and where appropriate further advice from local authority arboriculturists.

NJUG Guidelines for the Planning, Installation and Maintenance of Utility Apparatus in Proximity to Trees

(iv) Legislative mechanisms for ensuring that existing trees (including shrubs and hedges) are safeguarded already exist (see sub-section 7 – ‘Legislation’). References to legislation relate to the whole of the United Kingdom (UK) but variations between countries may occur. They seek to provide constructive advice on how to minimise damage to trees by undertakers (utilities) and to utility apparatus by trees and will be helpful to utility companies, contractors, arboriculturists, highway engineers, developers and planners. The guidelines have been prepared in collaboration between representatives of the utilities, the arboricultural and urban forestry professions and the Department for Communities and Local Government. As with all guidelines, their interpretation and application should be complimented at all times by common sense. However, expert guidance on specific instances should be sought from the appropriate utility, local authority or arboriculturist. The emphasis throughout this document is on the need for local liaison and communication.

(v) Certain trees are subject to Tree Preservation Orders (TPOs). Trees protected by a TPO must not be willfully damaged or destroyed and cannot be cut down, uprooted, topped or lopped without the local planning authority consent.

(vi) These guidelines are applicable to all apparatus (underground and overhead) and to trees in any location (public or private, rural or urban). They should be considered when new apparatus is planned to be constructed adjacent to existing trees, when new trees are to be planted adjacent to existing apparatus and where apparatus is to be maintained or repaired and trees are to be managed (e.g. pruning, removal or replacement).

(vii) Site surveys should be undertaken appropriate to the scale of the planned works. These surveys will identify the presence of trees which could impact on works. Advice should then be sought from a local authority tree officer. However, on major projects, a consultant arboriculturist may be employed to liase with the local authority tree officer. Site surveys should be carried out according to the recommendations within BS 5837 (see sub-section 8 – ‘Other Useful Publications’).

(viii) The principles set out in these guidelines also have relevance in respect of work carried out to highways near trees (e.g. kerbing, footway reinstatement).

NJUG Guidelines for the Planning, Installation and Maintenance of Utility Apparatus in Proximity to Trees

1. HOW TREES ARE DAMAGED

Trees are complex living organisms, which are susceptible to damage from a wide range of physical agents or activities. Trees do not heal, damage caused to a tree will remain for the rest of its life. Even minor damage may set up circumstances leading to serious long term decay.

Contrary to popular belief, the root system of a tree is not a mirror image of the branches, nor is there usually a 'tap root'. The majority of the root system of any tree is in the surface 600mm of soil, extending radially in any direction for distances frequently in excess of the tree's height. Excavation or other works within this area are liable to damage the roots.

1.1 The Root System

The base of a trunk typically flares out in buttresses extending into the main lateral structural roots. These rapidly subdivide into the mass of smaller roots which serve to anchor the tree into the soil and transport water and nutrients. Even at a short distance (3m) from a large mature tree, most roots will be less than 10mm in diameter, but these may extend to well beyond the branch spread of the tree. A mass of fine roots, less than 1 mm in diameter, develop off all parts of this root system. These fine roots also absorb the water and nutrients, which are essential for the growth of the tree.



NJUG Guidelines for the Planning, Installation and Maintenance of Utility Apparatus in Proximity to Trees

The main structural roots (close to the trunk) develop as the tree grows in response to the need for physical stability. Beyond these major roots growth is influenced by the availability of water, air and nutrients in the soil. Disturbance of soil provides ideal conditions for root growth. Apparatus is often cooler than the surrounding soil encouraging moisture within the soil to condense on its surface stimulating root growth close to the apparatus. For all these reasons root growth is often most prolific within the backfilled trench and in the soil around the apparatus.

There are certain areas around trees, illustrated in Figure 1 – ‘Tree Protection Zone’, where excavation either must not be undertaken or only undertaken under strict conditions in order to avoid or minimise any damage to a tree’s root system.

For the purposes of this guideline document they are called zones;

- the Prohibited Zone (1m from the trunk)
- the Precautionary Zone (4 x the tree circumference)
- the Permitted Zone (outside of the Precautionary Zone)

NJUG Guidelines for the Planning, Installation and Maintenance of Utility Apparatus in Proximity to Trees

FIGURE 1 – Tree Protection Zone

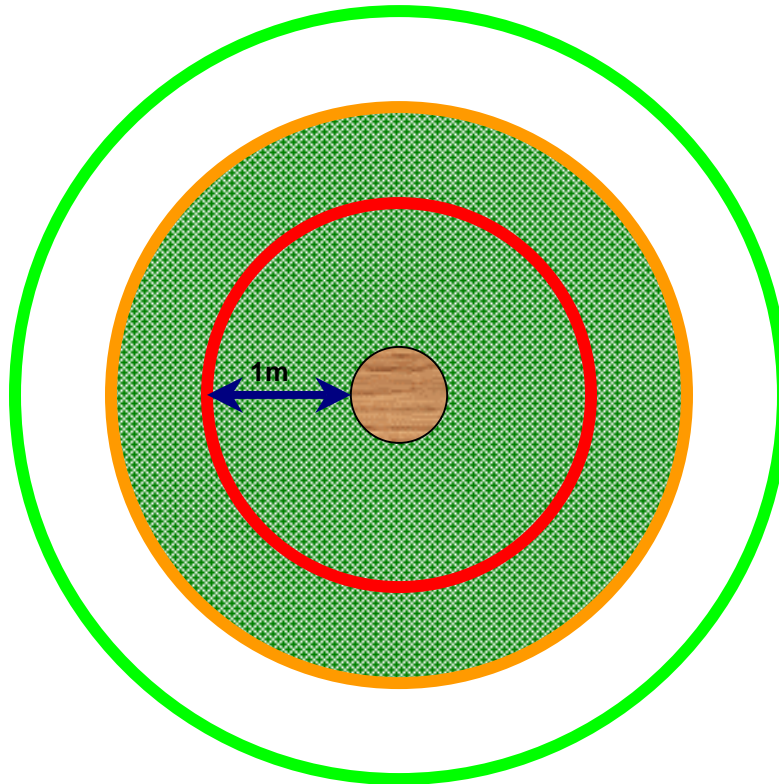

Key



Trunk of tree

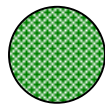

Canopy or branch spread



PROHIBITED ZONE – 1m from trunk. Excavations of any kind must not be undertaken within this zone unless full consultation with the local authority Tree Officer is undertaken. Materials, plant and spoil must not be stored within this zone.



PRECAUTIONARY ZONE – 4 x tree circumference. Where excavations must be undertaken within this zone the use of mechanical excavation plant should be prohibited. Precautions should be undertaken to protect any exposed roots. Materials, plant and spoil should not be stored within this zone. Consult with the local authority Tree Officer if in any doubt.



PERMITTED ZONE – outside of the precautionary zone. Excavation works may be undertaken within this zone, however caution must be applied and the use of mechanical plant limited. Any exposed roots should be protected.

NJUG Guidelines for the Planning, Installation and Maintenance of Utility Apparatus in Proximity to Trees

1.2 Below Ground

1.2.1 Root systems can be damaged by;

- the severance of a root, for example by trenching will destroy all parts of the root beyond that point. Even roots less than 10mm in diameter may be serving the fine roots over a wide area. The larger the root severed, the greater the impact on the tree.



Typical root damage caused by excavation works

- damage to the bark on the root. The bark protects the root from decay and is also essential for further root growth. It is loosely attached and easily damaged. If damage to the bark extends around the whole circumference the root beyond that point will be killed.
- damage to surface roots. Care must be taken when using mechanical plant. Materials and vehicles must never be stored within the Prohibited Zone and ideally should not be stored within the Precautionary Zone.

NJUG Guidelines for the Planning, Installation and Maintenance of Utility Apparatus in Proximity to Trees

- compaction of the soil. Incidental compaction may occur from storage of materials and / or the passing of heavy equipment over the roots. This can restrict or even prevent gaseous diffusion through the soil, and thereby asphyxiate the roots. The roots must have oxygen for survival, growth and effective functioning.



Poor site management within the Precautionary Zone

- alterations in soil level. Lowering the level will strip out the mass of roots near the surface. Raising levels will have the same effect as soil compaction.
- the application of herbicide - frequently used to clear weed growth on operational land (e.g. substations). The wide-ranging root system of a tree may extend into the operational land and absorb herbicides, which have been applied to the ground. Herbicide absorbed in one part of the root system can kill the whole tree.

NJUG Guidelines for the Planning, Installation and Maintenance of Utility Apparatus in Proximity to Trees

NOTE: The selection and application of herbicides must be undertaken by a competent person in accordance with Control of Substances Hazardous to Health (COSHH) regulations.

- spillage of oils or other materials (e.g. diesel oil, cement, resins). Spillage can permeate into the soil and damage root systems (see sub-section 4.3 – ‘Chemical Damage to Trees’).

1.2.2 If roots are damaged;

- close to the trunk. The anchorage and stability of the tree may be adversely affected rendering the tree immediately hazardous.
- anywhere along their length. The distal portion including the fine roots they serve, will be destroyed. Damage to fine roots by severance of a main root, or by compaction or alteration of ground levels, will prevent fine roots from absorbing the water and nutrients which are essential for the well-being, growth and anchorage of the tree.
- by successive excavations. Multi-utility excavations close to a tree can cumulatively damage a root system.

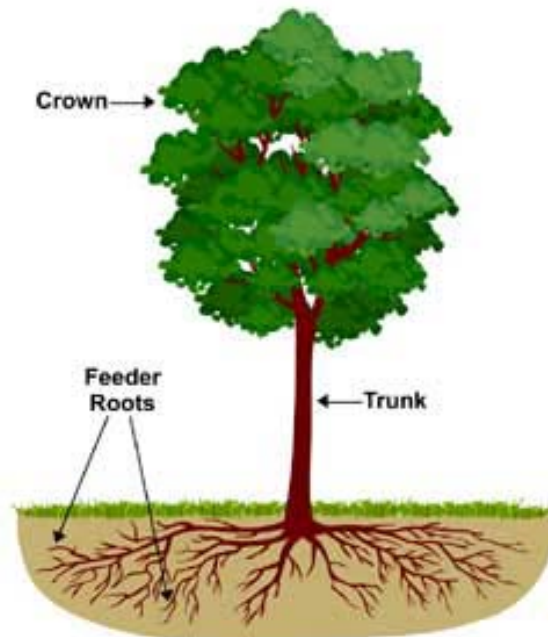

Figure 2 - Typical Tree Structure

NJUG Guidelines for the Planning, Installation and Maintenance of Utility Apparatus in Proximity to Trees

1.2.3 Symptoms

Trees with damage may not show any immediate symptoms. Such symptoms may range from minor branch dieback to deterioration and ultimate death and collapse of the tree dependent on the severity of damage and the ability of the roots to regenerate.

If a root of 25mm diameter or over is severed, as a precautionary measure, a local authority tree officer / arboricultural officer should be contacted immediately.

1.3 Above Ground

Trees have a single or multi-stemmed trunk supporting a framework of branches and twigs. These structures are protected by a layer of bark, the purpose of which is to protect the functional tissues immediately beneath.

Trees can be damaged by:

- Direct impact by plant or machinery
- Fire and scorching.
- Poor pruning
- Abrasion by overhead apparatus
- Chemicals and fuel oils
- Storage of materials within the Prohibited and Precautionary Zones

1.3.1 Abrasion

The tree may be damaged by abrasion with overhead apparatus. Initially this only removes the outer bark. If the abrasion continues it can expose the underlying wood which may increase the risk of fire or eventual collapse of the branch or the tree.

If trees are growing in proximity to overhead apparatus it should be possible to prevent the development of problems by timely pruning and tree management. This requires knowledge of the growth pattern of the many different species of tree, consideration of the effects of the pruning on the appearance of the tree and application of the correct pruning techniques. All pruning should be in accordance with BS 3998 (see sub-section 8 – ‘Other Useful Publications’). All operatives should be authorised and competent.

For all works other than emergency or urgent works, notification and consultation with all interested parties is necessary before work commences (see section 5 – ‘How to Avoid Damage to Apparatus by Trees’).

NJUG Guidelines for the Planning, Installation and Maintenance of Utility Apparatus in Proximity to Trees

1.3.2 Permissions / Notifications

Any work to trees adjacent to an area of operations that extends beyond what is absolutely necessary for operational requirements may require either written permission from the local planning authority (in respect to tree preservation orders) or six weeks' notification to the local planning authority (in respect to trees in conservation areas)(see also section 6 – 'Sites with Designated Status').

2. HOW APPARATUS IS DAMAGED

The positioning and type of underground apparatus are detailed in NJUG publication **Volume 1 – 'NJUG Guidelines on the Positioning and Colour Coding of Underground Utilities' Apparatus**.

Construction methods and utility service materials are subject to change and any cluster of utility services is likely to consist of a variety of historic and modern materials constructed to various specifications. In general utility apparatus includes the following:

- Pipes
- Cables
- Ducts
- Chambers
- Poles/Towers/Masts/Satellite dishes
- Above ground installations

2.1 Below Ground

Underground apparatus (especially those less than 600mm deep) may be affected by tree roots. The risk will depend on the ability of the apparatus, in particular any joints, to resist or tolerate distortion.

2.1.1 Direct damage

Direct damage is caused by the annual increase in root thickness resulting in eventual contact with apparatus. However, it is usually either the root or the adjacent soil that will distort rather than the apparatus itself. The potential for damage depends on how much the root thickens and is greatest in the main structural roots within 3 metres of the tree. Roots may grow around an apparatus to form a sheath but this will rarely exert sufficient pressure to cause any damage. Surface wrappings inadequately attached to an apparatus, if non-toxic, may be colonised by roots and eventually lifted off.

NJUG Guidelines for the Planning, Installation and Maintenance of Utility Apparatus in Proximity to Trees

2.1.2 Indirect damage

Indirect damage is restricted to shrinkable soils, mainly clays but also peat and some silts. Such soils shrink as they dry with the potential to distort any apparatus supported by the soil. Vegetation growing within the same area of soil may increase the drying effect.

The degree of the shrinkability of the soil will affect the amount of movement caused by drying and thus the potential for damage to occur. In situations where apparatus passes from a shrinkable soil into a rigid structure there is the possibility of extreme distortion taking place. Regular seasonal movement can also cause damage even in the absence of roots, particularly with short segmented pipes (see sub-section 3.1.4 – ‘Shrinkable Soils’).

2.1.3 Root incursion

Intact apparatus will not generally be penetrated by roots. However roots can exploit existing defects such as;

- defective pipe joints
- cracks in foul or surface water drains
- inadequate or degraded pointing of inspection chambers.

Where internal conditions are moist and aerated and therefore most conducive to root growth, root proliferation may occur and ultimately block the apparatus. If root thickening occurs where it passes into apparatus, root related enlargement of a defect may occur. This is unlikely at distances 3 metres or more from the trunk.

2.1.4 Trees and Wind Movement.

The potential for damage to apparatus close to a tree may increase due to movement of the lower trunk and a structural root as the tree sways in strong winds. Such movement may result in direct pressure being applied to the apparatus. Furthermore, if a tree is uprooted, any apparatus passing across or through the disturbed root plate may also be displaced. Such events are unlikely and are restricted to situations where apparatus is in close proximity to the trunk of the tree, but the potential may be increased if other structural roots are severed. Encasing apparatus in lean mix or course concrete can exacerbate this problem as fine roots may penetrate the material providing a greater ‘hold’ on the apparatus unless an appropriate root barrier material is used to separate the apparatus from the root system.

NJUG Guidelines for the Planning, Installation and Maintenance of Utility Apparatus in Proximity to Trees

2.1.5 Mechanical Removal of Trees and Stumps

The mechanical removal of tree stumps by grinding or grubbing may disturb or damage apparatus passing across or through the root plate of the tree. Using a mechanical digger to uproot a tree scheduled for removal is very likely to damage apparatus within and also close to the Prohibited or Precautionary Zones as the roots will apply pressure to the apparatus as they are uprooted.

2.2 Above Ground

If overhead apparatus come into contact with trees they may be damaged as a result of:

- Abrasion when the tree and / or apparatus move in the wind bringing them into contact. The resultant abrasion can damage wires affecting their efficiency, strength and causing interference or loss of supply.
- The collapse of a branch or a whole tree which could bring down overhead lines.

3. PLANNING OF WORKS

The inherently variable nature of trees, and also the generally low incidence of damage to underground apparatus, makes it neither practical nor justifiable to impose absolute limits on the proximity of trees to apparatus. Therefore site specific liaison and agreement between the asset owner and other interested parties is essential.

With respect to overhead apparatus there are minimum established clearances which must be maintained. Details of these clearances can be obtained from the utility network operator.

Before new trees are planted the advice of a local authority tree officer or arboriculturist should be obtained.

3.1 Special Considerations when Planning the Installation of Underground Apparatus

3.1.1 New / Renewal of Apparatus - New Trees

In considering the location of new or renewed apparatus in conjunction with a new tree planting scheme early consultation is essential between the relevant

NJUG Guidelines for the Planning, Installation and Maintenance of Utility Apparatus in Proximity to Trees

professional organizations e.g. local authorities, utility companies, developers and landowners

3.1.2 New / Renewal of Apparatus - Existing Trees

When planning the installation or renewal of apparatus the position of existing trees should be considered as one of the primary factors which could affect the siting, depth, method of installation and future maintenance of that apparatus.

Consultation with the relevant interested parties will identify any conflict and consideration should be given to apparatus diversion or felling and re-planting. This decision should be influenced by the value of the tree and the extent of the additional diversionary works.

3.1.3 Existing Apparatus - New Trees

Early consultation with utilities should take place before any tree work, including planting, is undertaken to ascertain the position of existing apparatus. Records of underground apparatus should be obtained from utilities and used in conjunction with on site apparatus detection techniques. The guidance contained within Health and Safety Executive guidance note HSG47 – ‘Avoiding Danger from Underground Services’ should be followed when excavating. In addition, when planning new tree planting, there should be liaison with the utilities, local authority and landowner so that the risks trees may pose to utility apparatus in the future are minimised.

3.1.4 Shrinkable Soils

Apparatus laid in clay or peat should be constructed to tolerate movements of the subsoil caused by root activity. Special precautions for differential movement should be incorporated where apparatus joins rigid structures founded at a different depth to the apparatus (e.g. pipe connections to chambers). See sub-section 2.1.2 ‘Indirect Damage’.

3.2 Precautions when Repairing Existing Apparatus

Where apparatus requires repair the location of the excavation is often defined by the location of the fault. The nature of the work usually requires open excavation. Excavation within the Prohibited and Precautionary Zones should be in accordance with sub-section 4.1 ‘Below Ground’ except for emergency or urgent works.

Where emergency or urgent works may have caused damage to roots with a diameter in excess of 25mm, interested parties should be informed immediately. They may choose to consult a local authority tree officer or arboriculturist regarding whether remedial treatment to the tree is necessary.

NJUG Guidelines for the Planning, Installation and Maintenance of Utility Apparatus in Proximity to Trees

If roots have grown into a drain or duct and proliferated so as to cause a blockage, the removal of the root mass from within the drain or duct will only provide temporary relief. If the root, which originally penetrated the drain, is still present it will regenerate and recreate the same problem. Roots of other plants may have a similar effect. Permanent relief can only be obtained by the proper repair of the original defect e.g. by replacement or refurbishment.

Utility apparatus may be refurbished by the use of pre-fabricated, slip lined or cured-in-place lining systems or pipes. Pre-fabricated and slip lined systems and pipes are generally resistant to root growth / intrusion, but cured-in-place linings may deform and ultimately collapse from the incursion of root growth. Following pre-survey (e.g. CCTV), it is essential that any roots are removed from the bore of the apparatus as far as practicable prior to lining, by the use of proprietary root removal systems (e.g. high-pressure water, flails, or rotating blade cutters).

3.3 Special Considerations when Planning the Installation of Above Ground Apparatus

The aerial parts of a tree are constantly growing larger and are prone to bend and flex in windy conditions. As a result parts of a tree may come close to or into contact with above ground apparatus.

3.3.1 Electricity

The overhead apparatus belonging to the electricity supply industry is subject to minimum clearances from adjacent trees and other structures. This is to ensure the safety of the public and protect against flashover and loss of supply. Local conditions may require an increase in the clearances specified in current electricity industry standards.

Part IV of The Electricity Supply Regulations covers the construction of power lines above ground. Schedule 4(9) of the Electricity Act 1989 enables electricity companies to require the felling or lopping of trees which obstruct or interfere with the working of their lines or constitute an unacceptable source of danger.

In addition to the above reference should be made to the Energy Networks Association (ENA) document Engineering Recommendation G55/1- Safe Tree Working in Proximity to Overhead Electric Lines (see section 8).

3.3.2 Communications

Communication operators run their systems under the Telecommunications Act 1984 (as amended by the Communications Act 2003) in accordance with The

NJUG Guidelines for the Planning, Installation and Maintenance of Utility Apparatus in Proximity to Trees

Telecommunications Code (Schedule 2). Paragraph 19 of the Telecommunications Code enables operators to require the lopping of trees which overhang the street and obstruct or interfere with the working of their lines.

4. HOW TO AVOID DAMAGE TO TREES

This section gives general guidance on methods of work to minimise damage to trees. The local authority (or for privately owned trees, the owner or their agent), should be consulted at an early stage prior to the commencement of any works. This will reduce the potential for future conflict between trees and apparatus.

4.1 Below Ground

Wherever trees are present, precautions should be taken to minimise damage to their root systems. As the shape of the root system is unpredictable, there should be control and supervision of any works, particularly if this involves excavating through the surface 600mm, where the majority of roots develop.

4.1.1 Fine Roots

Fine roots are vulnerable to desiccation once they are exposed to the air. Larger roots have a bark layer which provides some protection against desiccation and temperature change. The greatest risk to these roots occurs when there are rapid fluctuations in air temperature around them e.g. frost and extremes of heat. It is therefore important to protect exposed roots where a trench is to be left open overnight where there is a risk of frost. In winter, before leaving the site at the end of the day, the exposed roots should be wrapped with dry sacking. This sacking must be removed before the trench is backfilled.

4.1.2 Precautions

The precautions referred to in this section are applicable to any excavations or other works occurring within the Prohibited or Precautionary Zones as illustrated in Figure 1 – ‘Tree Protection Zone’.

4.1.3 Realignment

Whenever possible apparatus should always be diverted or re-aligned outside the Prohibited or Precautionary Zones. Under no circumstances can machinery be used to excavate open trenches within the Prohibited Zone.

NJUG Guidelines for the Planning, Installation and Maintenance of Utility Apparatus in Proximity to Trees

The appropriate method of working within the Precautionary Zone should be determined in consultation with the local authority (or for privately owned trees the owner or their agent) and may depend on the following circumstances;

- the scope of the works (e.g. one-off repair or part of an extensive operation)
- degree of urgency (e.g. for restoration of supplies)
- knowledge of location of other apparatus
- soil conditions
- age, condition, quality and life expectancy of the tree

Where works are required for the laying or maintenance of any apparatus within the Prohibited or Precautionary Zones there are various techniques available to minimise damage.

Acceptable techniques in order of preference are;

a) Trenchless

Wherever possible trenchless techniques should be used. The launch and reception pits should be located outside the Prohibited or Precautionary Zones. In order to avoid damage to roots by percussive boring techniques it is recommended that the depth of run should be below 600mm. Techniques involving external lubrication of the equipment with materials other than water (e.g. oil, bentonite, etc.) must not be used when working within the Prohibited Zone. Lubricating materials other than water may be used within the Precautionary Zone following consultation and by agreement.

b) Broken Trench - Hand-dug

This technique combines hand dug trench sections with trenchless techniques if excavation is unavoidable. Excavation should be limited to where there is clear access around and below the roots. The trench is excavated by hand with precautions taken as for continuous trenching as in (c) below. Open sections of the trench should only be long enough to allow access for linking to the next section. The length of sections will be determined by local conditions, especially soil texture and cohesiveness, as well as the practical needs for access. In all cases the open sections should be kept as short as possible and outside of the Prohibited Zone.

NJUG Guidelines for the Planning, Installation and Maintenance of Utility Apparatus in Proximity to Trees

c) Continuous Trench - Hand-dug

The use of this method must be considered only as a last resort if works are to be undertaken by agreement within the Prohibited Zone. The objective being to retain as many undamaged roots as possible.

Hand digging within the Prohibited or Precautionary zones must be undertaken with great care requiring closer supervision than normal operations.

After careful removal of the hard surface material digging must proceed with hand tools. Clumps of roots less than 25mm in diameter (including fibrous roots) should be retained in situ without damage. Throughout the excavation works great care should be taken to protect the bark around the roots.

All roots greater than 25mm diameter should be preserved and worked around. These roots must not be severed without first consulting the owner of the tree or the local authority tree officer / arboriculturist. If after consultation severance is unavoidable, roots must be cut back using a sharp tool to leave the smallest wound.

4.1.5 Backfilling

- Any reinstatement of street works in the United Kingdom must comply with the relevant national legislation (see: **Volume 6 – ‘Legislation and Bibliography’**). In England this relates to the requirements of the code of practice – ‘Specification for the Reinstatement of Openings in Highways’ approved under the New Roads and Street Works Act 1991. Without prejudice to the requirements relating to the specification of materials and the standards of workmanship, backfilling should be carefully carried out to avoid direct damage to roots and excessive compaction of the soil around them.
- The backfill should, where possible, include the placement of an inert granular material mixed with top soil or sharp sand (not builder’s sand) around the roots. This should allow the soil to be compacted for resurfacing without damage to the roots securing a local aerated zone enabling the root to survive in the longer term.
- Backfilling outside the constructed highway limits should be carried out using the excavated soil. This should not be compacted but lightly “tamped” and usually left slightly proud of the surrounding surface to allow natural settlement. Other materials should not be incorporated into the backfill.

NJUG Guidelines for the Planning, Installation and Maintenance of Utility Apparatus in Proximity to Trees

4.1.6 Additional Precautions near Trees

- Movement of heavy mechanical plant (excavators etc.) must not be undertaken within the Prohibited Zone and should be avoided within the Precautionary Zone, except on existing hard surfaces, in order to prevent unnecessary compaction of the soil. This is particularly important on soils with a high proportion of clay. Spoil or material must not be stored within the Prohibited Zone and should be avoided within the Precautionary Zone.
- Where it is absolutely necessary to use mechanical plant within the Precautionary Zone care should be taken to avoid impact damage to the trunk and branches. A tree must not be used as an end-stop for paving slabs or other materials nor for security chaining of mechanical plant. If the trunk or branches of a tree are damaged in any way advice should be sought from the local authority tree officer / arboriculturist.

See TABLE 1 –‘Prevention of Damage to Trees Below Ground’ below for summary details regarding causes and types of damage to trees and the implications of the damage and the necessary precautions to be taken to avoid damage.

NJUG Guidelines for the Planning, Installation and Maintenance of Utility Apparatus in Proximity to Trees

TABLE 1 - Prevention of Damage to Trees Below Ground

Causes of Damage	Type of Damage	Implications to Tree	Precautions
Trenching, mechanical digging etc.	Root severance	<ul style="list-style-type: none"> The tree may fall over Death of the root beyond the point of damage Potential risk of infection of the tree <p>The larger the root the greater the impact on the tree.</p>	Hand excavate only within the Precautionary Zone. Work carefully around roots. Do not cut roots over 25mm in diameter without referring to the local authority tree officer. For roots less than 25mm in diameter use a sharp tool and make a clean cut leaving as small a wound as possible.
Trenching, mechanical digging, top soil surface removal etc.	Root bark damage	<ul style="list-style-type: none"> The tree may fall over If the damage circles the root it will cause the death of the root beyond that point Potential risk of infection of the tree <p>The larger the root the greater the impact on the tree.</p>	Do not use mechanical machinery to strip the top soil within the Precautionary Zone. Hand excavate only within the Precautionary Zone. Work carefully around roots. Do not cut roots over 25mm in diameter without referring to the local authority tree officer. For roots less than 25mm use a sharp tool and make a clean cut leaving as small a wound as possible.
Vehicle movement and plant use. Material storage within the precautionary area.	Soil compaction & water saturation	Restricts or prevents passage of gaseous diffusion through soil, the roots are asphyxiated and killed affecting the whole tree.	Prevent all vehicle movement, plant use or material storage within the Precautionary Zone.
Top-soil scouring, excavation or banking up.	Alterations in soil level causing compaction or exposure of roots.	Lowering levels strips out the mass of roots over a wide area. Raising soil levels asphyxiates roots and has the same effect as soil compaction.	Avoid altering or disturbing soil levels within the Precautionary Zone.
Use of herbicides.	Poisoning of the tree via root absorption	<ul style="list-style-type: none"> Death of the whole tree Death of individual branches <p>Damage to leaves and shoots.</p>	The selection and application of herbicides must be undertaken by a competent person in accordance with COSHH regulations.
Spillage of oils or other materials.	Contamination of soil	Toxic and asphyxiation effects of chemicals, oils, building materials (cement, plaster, additives etc.) on the root system can kill the tree.	Never store oils, chemicals or building materials within the Precautionary Zone or within the branch spread of a tree, which ever is the greater.
Placement or replacement of underground apparatus.	Various	Death of all or part of the tree.	Effective planning and liaison with local authority tree officer, taking into consideration the position of trees, and their future growth potential and management



NJUG Guidelines for the Planning, Installation and Maintenance of Utility Apparatus in Proximity to Trees

4.2 Above Ground

4.2.1 Damage by Pruning

Trees (including shrubs and hedges) can be damaged by inappropriate or excessive pruning. Reference should be made to the Energy Networks Association (ENA) document “Engineering Technical Report 136 Vegetation Management near Electricity Equipment – Principles of Good Practice” (see section 8 – ‘Other Useful Publications’) or appropriate company specific documentation for guidance on pruning.

See TABLE 2 – ‘Prevention of Damage to Trees Above Ground’ below for summary details regarding causes and types of damage to trees and the implications of the damage and the necessary precautions to be taken to avoid damage.

NJUG Guidelines for the Planning, Installation and Maintenance of Utility Apparatus in Proximity to Trees

TABLE 2 - Prevention of Damage to Trees Above Ground

Causes of Damage	Type of Damage	Implications for the Tree	Precautions
Impact by vehicle or plant Physical attachment of signs or hoardings to the trunk Storage of materials at base of tree Rubbing by winch or pulling cables	Bark bruising, bark removal, damage to the wood, damage to buttress roots, abrasion to trunk	Wounding with the potential for infection ultimately resulting in death of all or part of the tree. Structural failure of the tree	Surround the trunk with protective free-standing barrier. Exclude vehicles, plant or material storage from the Precautionary Zone. Ensure sufficient clearance of cables or ropes.
Impact by vehicle or plant Rubbing by overhead cables	Bark damage to branches, breakage and splitting of branches, abrasion to branches	Structural failure of the branch. Wounding or loss of a branch with the potential for infection ultimately resulting in death of all or part of the branch or tree.	Exclude vehicles, plant or material storage from the Precautionary Zone. Ensure sufficient clearance of cables or ropes. All pruning should be carried out in accordance with BS3998 (<i>prune affected branches to give appropriate clearance from cables</i>)
Inappropriate siting of overhead apparatus, such as CCTV, lighting fixtures and communications masts and dishes.	Inappropriate pruning, unnecessary tree removal	Severely pruning tree to acquire line of sight signal for communications dish etc.	Effective planning and liaison with local authority tree officer / arboriculturist, taking into consideration the position of trees, and their future growth potential and management.
Lack of forethought in design and location of apparatus and services entries on new developments	Complete tree removal	The tree is removed unnecessarily	Agree the location and installation of services at the design stage. Consideration should be given to the creation of dedicated service routes wherever possible.
Use of herbicides	Poisoning of the tree via absorption through bark, leaves and shoots	Death of the whole tree, death of individual branches, damage to leaves and shoots	The selection and application of herbicides must be undertaken by a competent person in accordance with COSHH regulations.

NJUG Guidelines for the Planning, Installation and Maintenance of Utility Apparatus in Proximity to Trees

4.3 Chemical Damage to Trees

Chemical damage to trees adjacent to utility premises and operational land can be avoided if;

- the risk is identified when planning any work involving herbicides or other chemicals ensuring that only appropriate chemicals are used. Particular care should be exercised when considering the use of herbicides recommended for “non crop areas” as many of these also specify “do not use where there may be roots of desirable plants”,
- herbicides are applied only at the rate and in the manner recommended by the manufacturer,
- follow-up applications are not undertaken until weeds reappear on the operational land,
- alternative methods of weed control are considered.

5. HOW TO AVOID DAMAGE TO APPARATUS BY TREES

5.1 Consultation with Utilities

The potential for future conflict between trees and above-ground apparatus can be reduced by appropriate planning. Early consultation with utilities should therefore take place before any tree work including planting is undertaken to ascertain the position of existing apparatus. Records of underground apparatus should be obtained from utilities and used in conjunction with on site apparatus detection techniques. Specific care must be taken when removing the stumps of existing trees. In addition when planning new tree planting there should be liaison with the utilities, local authority and landowner so that the risks trees may pose in the future are minimised.

5.2 Precautions during Planting

Every possible precaution should be taken to ensure that the existing apparatus is not damaged during excavation works. Health and Safety Executive guidance note HSG47 – ‘Avoiding Danger from Underground Services’ and any specific guidance issued by the apparatus owner should be followed at all stages of the work.

NJUG Guidelines for the Planning, Installation and Maintenance of Utility Apparatus in Proximity to Trees

5.2.1 Below Ground

Before any excavation work begins, trial holes should be undertaken to validate the results of any detection surveys undertaken to confirm the actual position and depth of the apparatus.

5.2.2 Above Ground

Consideration should be given to the presence of satellite dishes and masts on commercial properties, poles and drop wires, as future tree growth may cause operational problems.

Reference should also be made to Energy Networks Association (ENA) document 'Engineering Technical Report 136 Vegetation Management near Electricity Equipment – Principles of Good Practice' (see section 8 – 'Other Useful Publications') or appropriate company specific documentation.

NOTE: In all cases where definitive clearances are required, contact must be made with the appropriate electricity or communication company who will determine the clearance to be adopted.

See also sub-section 3.3 – 'Special Considerations when Planning the Installation of Above Ground Apparatus'.

6. SITES WITH DESIGNATED STATUS

Certain sites may be specifically designated and will require consultation and / or permission from the relevant authority prior to undertaking any works. These sites include:

- Sites of Special Scientific Interest
- English Heritage Sites
- English Nature / Natural England
- National Trust Land
- Nature Reserves
- Conservation Areas
- Scottish Natural Heritage
- Areas of Outstanding Natural Beauty
- Countryside Council for Wales
- Historic Scotland
- Northern Ireland Environment and Heritage Service
- Cadw (Welsh Historic Monuments)

NJUG Guidelines for the Planning, Installation and Maintenance of Utility Apparatus in Proximity to Trees

6.1 Tree Preservation Orders and Trees in Conservation Areas

Section 198 of the Town and Country Planning Act 1990 (the Act) gives local planning authorities powers to make trees and woodlands the subject of tree preservation orders (TPOs) in the interests of amenity. Trees protected by a TPO may not be willfully damaged or destroyed and cannot be cut down, uprooted, topped or lopped without the local planning authority's consent.

Additionally, under section 211 of the Act, anyone proposing to cut down, uproot, top, lop etc. a tree in a conservation area is required to give the local planning authority six weeks' notice before doing so. This gives the authority an opportunity of making a TPO in respect of the tree.

Certain statutory obligations imposed by Acts of Parliament may allow for the limited felling, topping or lopping of trees protected by a TPO in order to supply and maintain service. This does not preclude the requirement to consult with the owner.

See also: **Volume 5 – 'NJUG Guidelines on Environmental Good Practice'**

7. LEGISLATION

Reference should also be made to **Volume 6 – 'Legislation & Bibliography'**.

7.1 Primary Legislation

National Parks and Access to the Countryside Act 1949*
Health and Safety at Work Act 1974
Highways Act 1980**
Telecommunications Act 1984
Gas Act 1986
Electricity Act 1989
Town and Country Planning Act 1990 (Section 198 Tree Preservation Orders).
Water Industry Act 1991
The New Roads and Street Works Act 1991 (NRSWA)
The Streets Works (Northern Ireland) Order 1995
Communications Act 2003
Traffic Management Act 2004
Transport (Scotland) Act 2005
The Streets Works (Northern Ireland) (Amendment) Order 2007

* Under the National Parks and Access to the Countryside Act 1949 local authorities are given a general power to plant trees.

NJUG Guidelines for the Planning, Installation and Maintenance of Utility Apparatus in Proximity to Trees

** Under the Highways Act 1980 highway authorities may plant trees in the highway, or license others to do so. They need to ensure that trees do not overhang or cause a danger to roads or footpaths, and are given powers to prevent this from happening.

The above list is not exhaustive.

7.2 Secondary Legislation

Each Act of parliament in 7.1 will have various associated regulations that should be referred to.

8. OTHER USEFUL PUBLICATIONS

This is not an exhaustive list of available publications and is only valid at the time of issue.

BS 3998 Recommendations for Tree Work

- Provides general recommendations for tree surgery and other tree work.

BS 5837 Trees in Relation to Construction

- Gives advice on the integration of new development amongst trees.

Codes of Practice approved under the New Roads and Street Works Act 1991

- Co-ordination of Street Works and Works for Road Purposes and Related Matters
- Specification for the Reinstatement of Openings in Highways
- Safety at Street Works and Road Works
- Measures Necessary where Apparatus is Affected by Major Works (Diversionary Works)
- Inspections

Energy Networks Association publications:

- Engineering Technical Report 136 'Vegetation Management Near Electricity Equipment – Principles of Good Practice'
- Engineering Recommendation G55/1 – 'Safe Tree Working in Proximity to Overhead Electric Lines'
- ENA-TS 40-80 – ENA Technical Standard for Overhead Line Clearances
- Engineering Recommendation G70 – Vegetation Control near Overhead Lines

NJUG Guidelines for the Planning, Installation and Maintenance of Utility Apparatus in Proximity to Trees

- ETR 132 – Improving Network Performance (under abnormal weather conditions by the use of a risk based approach to vegetation management near electric overhead lines)
- MNT/004 – UK Distribution Policy for the Inspection and Maintenance of Overhead Lines

HSE Arboriculture and Forestry Advisory Group publications

- AFAG 804 Electricity at work: Forestry and arboriculture
- AFAG 404 Electrical utility arboriculture

Manual for Streets (supercedes Design Bulletin 32 and Places, Streets and Movement)

- The Department for Transport and the Department for Communities and Local Government (DCLG), with support from the Commission for Architecture and the Built Environment (CABE), commissioned WSP , TRL , Llewellyn Davies Yeang and Phil Jones Associates to develop a Manual for Streets to give guidance to a range of practitioners on effective street design.

National House Building Council (NHBC) Standards Chapter 4.2. Building near trees

- Gives information on the design of new foundations in proximity to trees on shrinkable clay soils.

9. OTHER REFERENCES

9.1 Arboricultural

Arboricultural advice may be sought from the:

- Arboricultural Advisory and Information Service
- Arboricultural Association
- Arboriculture and Forestry Advisory Group
- International Society of Arboriculture
- Local authority Arboricultural Officer
- The Tree Advice Trust

9.2. Herbicides

Information on herbicides and their application may be obtained from the:

- British Agrochemicals Association

9.3 Utilities

Utility advice may be sought from the local utility contact or NJUG.

NJUG Guidelines for the Planning, Installation and Maintenance of Utility Apparatus in Proximity to Trees

GLOSSARY

Apparatus	Equipment such as valves, stopcocks, chambers, cabinets, transformer chambers etc and includes any structure for the lodging of apparatus.
Arboriculturist	A professional who cultivates and manages trees, hedgerows and shrubs and provides information and advice on specific tree related issues.
Carriageway	A way constituting or comprised in a highway, being a way (other than a cycle track) over which the public have a right of way for the passage of vehicles.
Cycle track	A way constituting or comprised in a highway over which the public have a right of way on pedal cycles with or without a right of way on foot.
Desiccation	The state of extreme dryness, the drying out of roots.
Distal	Situated farthest from the centre.
Drop wires	Overhead wire from telegraph pole to customer premises.
Duct / ducting	Structure (usually cylindrical) used to convey and protect apparatus.
Fibre optic	The use of very thin glass or plastic fibres through which light can be transmitted to carry information from a source to a receiver, especially for telecommunication, television and information technology systems.
Footpath	A highway over which the public have a right of way on foot only, not being a footway.
Footway	A way comprised in a highway which also comprises a carriageway, being a way over which the public have a right of way on foot only.
GRP	Glass Reinforced Plastic
Herbicide	A chemical that destroys plants.
Main	Structure (usually cylindrical) used to convey water or gas or oil generally greater than 50mm in diameter.
NJUG	National Joint Utilities Group Limited.
Pipe	Longitudinal structure (usually cylindrical) used to convey water, gas or oil.
Root plate	Formed just below the soil surface when shallow lateral growing roots predominate over the development of a deep taproot.



NJUG Guidelines for the Planning, Installation and Maintenance of Utility Apparatus in Proximity to Trees

Service strip	A strip of designated land alongside a carriageway or footway used to convey services.
Sub-duct	Longitudinal structure (usually cylindrical) laid inside ducts used to carry smaller diameter cables such as fibre optic.
Tiles	Impact resistant cover constructed of earthenware, concrete or polyethylene for protecting underground cables
Utility	An undertaker by statute that has a legal right to provide customer services (e.g. communications, electricity, gas, water)
Verge	A strip of land which may form part of the public highway alongside a carriageway or footway, which may contain services.

NJUG Guidelines for the Planning, Installation and Maintenance of Utility Apparatus in Proximity to Trees

APPENDIX A

Important Legal Notice and Disclaimer

1. This publication describes utility industry guidelines for the planning, installation and maintenance of utility apparatus in proximity to trees. NJUG has endeavoured to ensure that the information is correct and up-to-date at the date of first publication, but does not warrant its completeness and accuracy or that it will remain up-to-date. This publication is not intended to be exhaustive and may not be applicable in all situations.
2. You are permitted to print and download and make photocopies of this publication for your own use only on the following basis:
 - a) none of the information or related graphics in this publication are modified in any way;
 - b) no graphics in this publication are used separately from accompanying text; and
 - c) NJUG's copyright notices and this Legal Notice and Disclaimer are to appear in all copies
3. Unless otherwise stated, the copyright and other intellectual property rights in this publication are owned by NJUG Ltd or its licensors. For the purposes of this legal notice, any use of extracts from this publication other than expressly permitted by this legal notice, is prohibited. If you breach any of the terms in this legal notice, your permission to use this publication automatically terminates.
4. No part of this publication may be reproduced in any way (including via any website) or stored in any public or private electronic retrieval system or service without NJUG's prior written permission. Any rights not expressly granted in this legal notice are reserved.
5. This publication has no legal or statutory authority and is not intended to be a definitive or complete statement of the applicable law. Reference should always be made to any relevant legislation. This publication is not intended to be or to replace specific legal advice and all persons acting or placing reliance on this publication or any part of it are advised to consult with their own legal advisors to ensure that they understand and comply with the legal requirements which are applicable to their organisation and circumstances.

NJUG Guidelines for the Planning, Installation and Maintenance of Utility Apparatus in Proximity to Trees

6. Persons who act or place reliance on this publication are solely responsible for undertaking all surveys, enquiries, tests and other investigations as may be appropriate in the circumstances. NJUG Ltd and its directors, advisors and other contributors to this publication (together collectively referred to as 'NJUG') do not accept any responsibility for the actions or conclusions drawn by persons acting or placing reliance on this publication.
7. This publication is free of charge and persons relying on this publication acknowledge that it would be unreasonable to hold NJUG liable in respect of this publication and the information contained in it. NJUG excludes all liability to the maximum extent permitted under applicable law. NJUG shall not be liable for any direct, indirect or consequential losses, damage, costs or expenses whatsoever or howsoever sustained by any person acting or placing reliance on this publication (or any person or entity claiming through such person) or otherwise arising therefrom – whether arising in tort, contract or otherwise – including, without limitation, any loss of profits, contracts, business, goodwill, data, income, revenue or anticipated savings.
8. Nothing in this disclaimer shall exclude or limit NJUG's liability for death or personal injury arising from its negligence, nor any other matter which cannot be excluded or limited under applicable law.