



ENVIRONMENTAL SUSTAINABILITY

All of our composite decking, cladding and fencing materials are made using a mixture of reclaimed timber fibres, recycled HDPE and environmentally sustainable bonding agents and dyes to create high quality products that replicate the characteristics of timber without any of the drawbacks; like rotting, warping, drastic colour fading, ongoing maintenance etc.

The use of recycled HDPE plastics help aid in the battle to reduce landfill and ocean plastics but also reducing our carbon footprint.



Look for our FSC® certified products throughout the brochure.

The mark of responsible forestry
FSC® C181157



CONTENTS

4	CLARITY COMPOSITE DECKING
12	FORMA COMPOSITE DECKING
22	NEW LINEA COMPOSITE DECKING
30	GRANDE COMPOSITE DECKING
36	FORMA COMPOSITE PANEL CLADDING
46	FORMA COMPOSITE SLATTED CLADDING
58	CLARITY COMPOSITE FENCING & GATES
66	BALUSTRADE SYSTEMS
70	CRADLE & PEDESTAL SYSTEMS
80	FORTE TIMBER FREE SUBSTRUCTURES
82	NEW OUTDOOR KITCHENS
86	NEW BIN STORAGE



INNOVATIVE & SUSTAINABLE DESIGN

As manufacturers of wood plastic composite products, our collection includes attractive low maintenance decking, cladding, fencing and balustrade systems.

We aim to be at the forefront of the garden design industry with excellent quality, stylish and efficient systems that not only look beautiful but perform to the highest standard.

We use recycled plastic in all of our composite products. In 2022 alone we recycled 5,717 tons of waste plastic in our materials.

MIDNIGHT
Forma Composite
Slatted Cladding

CLARITY® COMPOSITE DECKING



CHARCOAL
Clarity Composite
Decking

Ecoscope Clarity® composite decking is a long lasting, low maintenance alternative to timber decking. Made up of recycled high density polyethylene plastic and reclaimed wood fibres. This unique makeup draws on the durability of synthetic products whilst maintaining the natural look and malleability of timber without any of its notable drawbacks.

This attractive and sustainable composite decking board is available in 4 beautiful colours and has a dual surface finish meaning the board can be laid either side up to achieve a different aesthetic.

Our Clarity® boards have also been independently tested to BS 7976-2:2002 and are slip resistant in both wet and dry conditions, making family safety one of its most attractive selling points.



AUTUMN
Clarity Composite
Decking



Clarity® boards are dual sided with wide grooves on one side and narrower grooves on the other.



Our T-Clip fixing system is engineered for quick and easy installation whilst maintaining a high quality finish. The clips space decking boards evenly allowing for expansion and contraction with temperature fluctuation.



WALNUT
Clarity Composite
Decking

Narrow
groove side

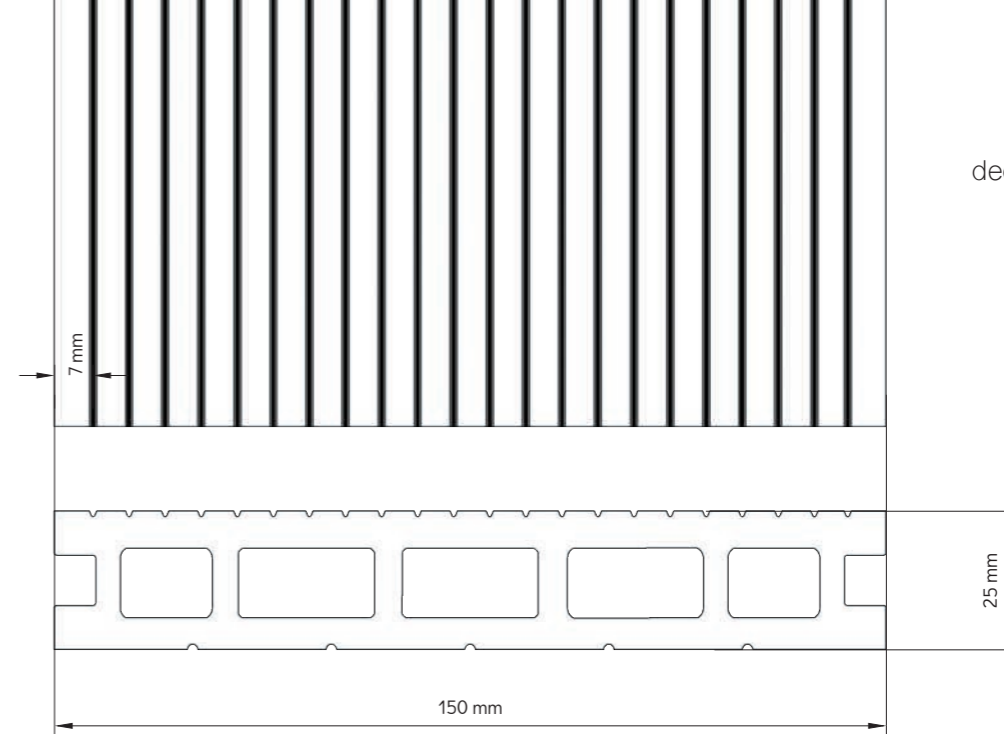

Clarity
decking board
dimensions

Wide
groove side



CLARITY® COMPOSITE DECKING



Walnut

25mm x 150mm x 3000mm
25mm x 150mm x 4800mm



Autumn

25mm x 150mm x 3000mm
25mm x 150mm x 4800mm



NOTE: Lighter Clarity boards will show greater colour settling due to smaller quantities of dye and greater UV exposure to the natural wood fibres. After 3 months of UV exposure colour remains consistent.



GRAPHITE
Clarity Composite Decking

Charcoal

25mm x 150mm x 3000mm
25mm x 150mm x 4800mm



Graphite

25mm x 150mm x 3000mm
25mm x 150mm x 4800mm

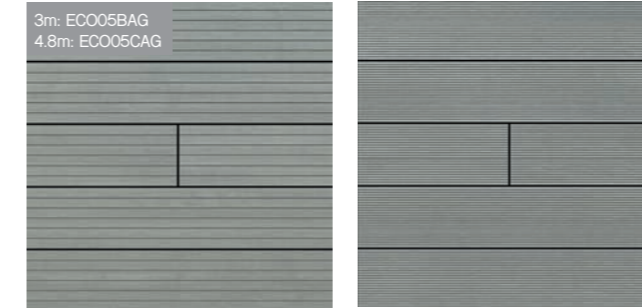

Dual surface boards, wide groove on one side, narrow groove on the other.



* 10% discount on Autumn and Walnut 4.8m lengths ONLY. Applied in addition to standard discount for merchant customers.

CLARITY® COMPOSITE DECKING ACCESSORIES

Angle Trim

42mm x 42mm x 3000mm

ECO06AX3

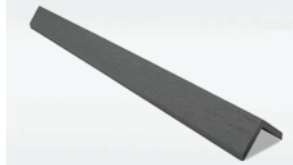

6mm trim thickness

Flat Fascia Trim

15mm x 150mm x 3000mm

ECO15015X

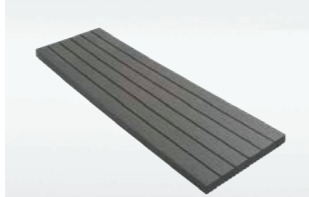

Dual sided

Solid Edge Board

25mm x 150mm x 3000mm

Wide groove: ECO07SX3W
Narrow groove: ECO07SX3

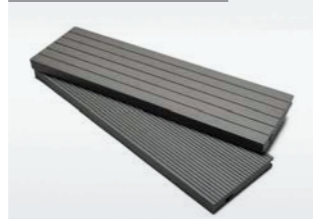

Hidden T- Clip Fixings

250pcs, incl screws & 1 drill bit

ECO09CS



Locking Clip Fixings

50pcs, incl screws

ECO09LC



Start/Finish Clips

50pcs

ECO09SF



Colour Coded Screws

63mm/40mm

63mm: ECO09CSXX
40mm: ECO09CSXX40



BENEFITS OF CLARITY® DECKING

Environmentally conscious design using 95% ethically sourced materials

Slip resistant surface

Low maintenance – no need to paint, stain or seal

Does not rot, warp or splinter

Natural looking without many of the drawbacks of timber

Easy installation system with invisible fixings

Extensive 20 year warranty



FLINT
Forma
Composite
Decking





Forma® composite decking is our premium composite with a durable polymer outer shell encapsulating the board. This capping forms an impermeable layer that protects from scratching, staining and fading making it the ultimate carefree, low maintenance flooring.

Available in six beautiful colours this stylish and sustainable decking board can instantly elevate any project into a luxury space.

The T-Clip fixing system allows boards to move freely with expansion and contraction preventing any buckling, twisting or warping. This clip is also conveniently hidden in the grooves of the decking board so there are no visible fixings through the top of the decking.



Our Locking Clip is similar to the T-Clip but with serrated teeth which locks the board in place. This ensures even expansion or contraction during hot or cold weather but prevents the board from sliding.



ARGENT
Forma
Composite
Decking



Forma decking board dimensions

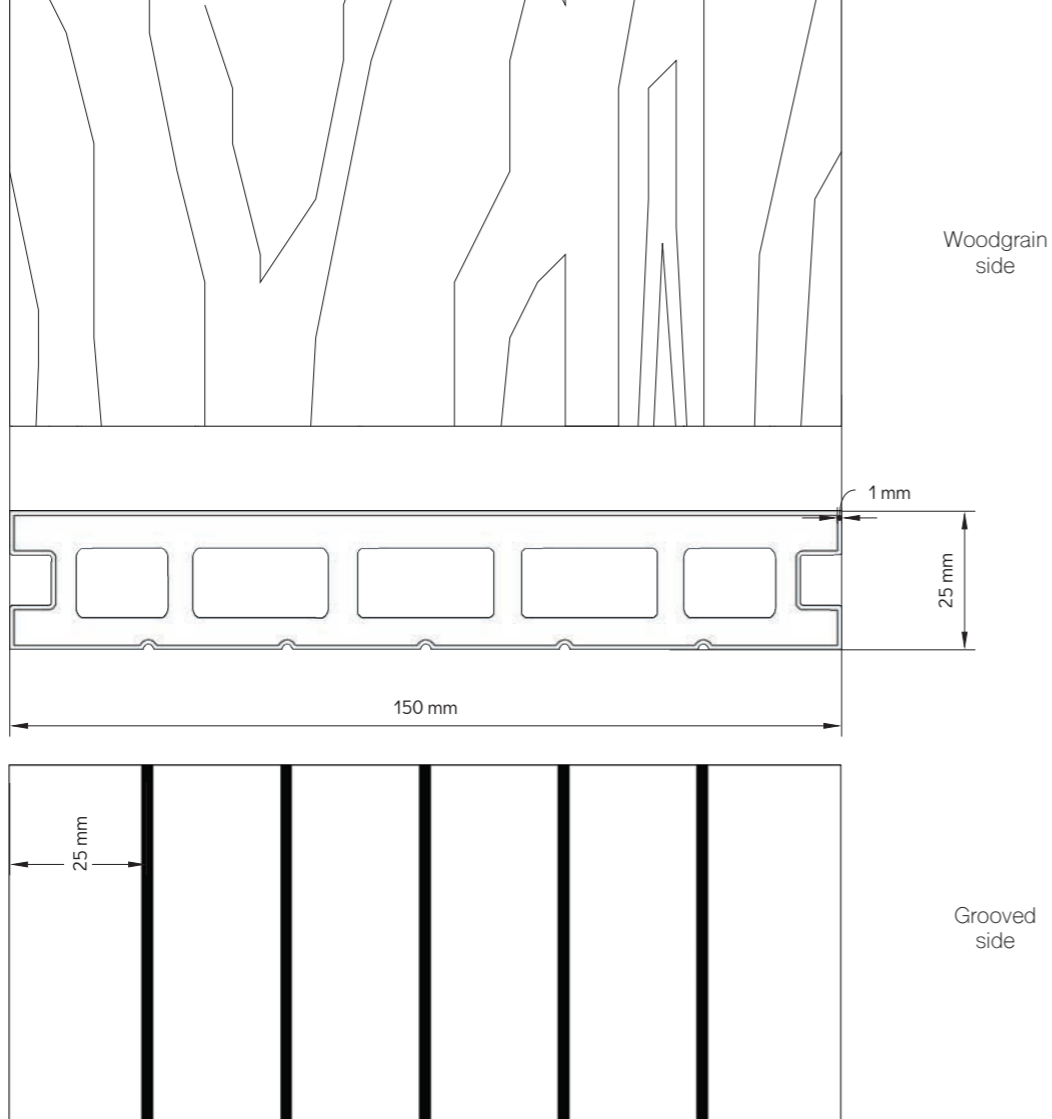

Forma's 360° co-extrusion durable capping is not only scratch and stain resistant. It also beautifully replicates the natural grain, dual tone and texture of timber.



With a 25 year warranty and UV bleaching resistant technology Forma decking requires minimal maintenance to keep its vibrant colour.

FORMA® COMPOSITE DECKING



Dual surface boards, wide groove on one side, woodgrain on the other.

Havana

25mm x 150mm x 3000mm
25mm x 150mm x 4800mm



Silver Birch

25mm x 150mm x 3000mm
25mm x 150mm x 4800mm



Flint

25mm x 150mm x 3000mm
25mm x 150mm x 4800mm

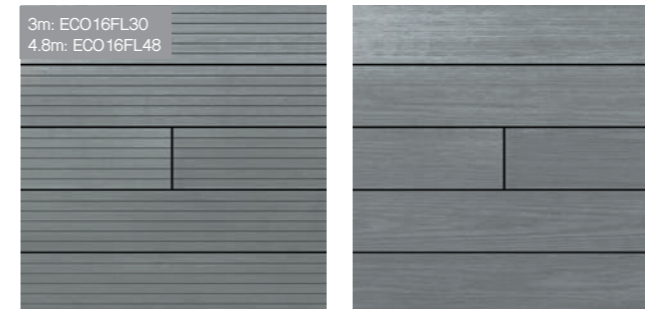

Argent

25mm x 150mm x 3000mm
25mm x 150mm x 4800mm



Spiced Oak

25mm x 150mm x 3000mm
25mm x 150mm x 4800mm

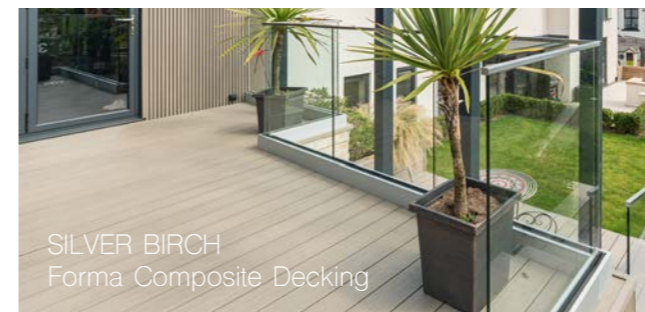
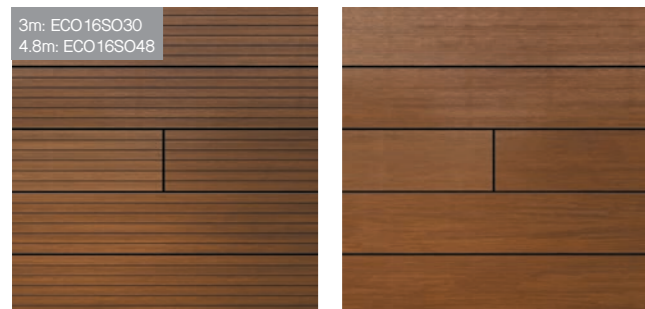

Midnight

25mm x 150mm x 3000mm
25mm x 150mm x 4800mm



FORMA® COMPOSITE DECKING ACCESSORIES

Angle Trim

40mm x 40mm x 3000mm

ECO18XX3



8mm trim thickness

Flat Fascia Trim

10mm x 150mm x 3000mm

ECO17XX3



Dual sided

Solid Edge Trim

25mm x 150mm x 3000mm

ECOFSOLXX3



Dual sided

Hidden Screws & Composite Plugs

Screw: ECO09HS
Plug: ECOCPXX



Hidden T- Clip Fixings

250pcs, incl screws & 1 drill bit

ECO09CS



Locking Clip Fixings

50pcs, incl screws

ECO09LC



Start/Finish Clips

50pcs

ECO09SF



Colour Coded Screws

63mm/40mm

63mm: ECO09CSXX
40mm: ECO09CSXX40



BENEFITS OF FORMA® DECKING

Environmentally conscious design using 95% ethically sourced materials

Durable capping for UV and stain resistance

Low maintenance – no need to paint, stain or seal

Does not rot, warp or splinter

Natural looking without many of the drawbacks of timber

Easy installation system with invisible fixings

Extensive 25 year warranty

NEW

LINEA COMPOSITE DECKING

GRANITE
Linea Composite
Decking

The latest addition to our decking collection is available in 4 colours and has a capped exterior protecting it from harmful UV rays, scratches and extreme weather. As with our other products, Linea is long lasting, low maintenance and sustainably produced using 95% recycled materials.



SLATE
Linea Composite
Decking

Each Linea deck board has its own distinct character through a unique colour streaking process that imitates natural timber and creates a truly individualised aesthetic.

NEW



Linea decking offers a capped board with a traditional groove pattern to one side and a modern straight grain to the other for a choice between a classic or a more streamlined aesthetic.



Traditional Groove Side

Straight Grain Side

ONYX
Linea
Composite
Decking

Linea
decking board
dimensions

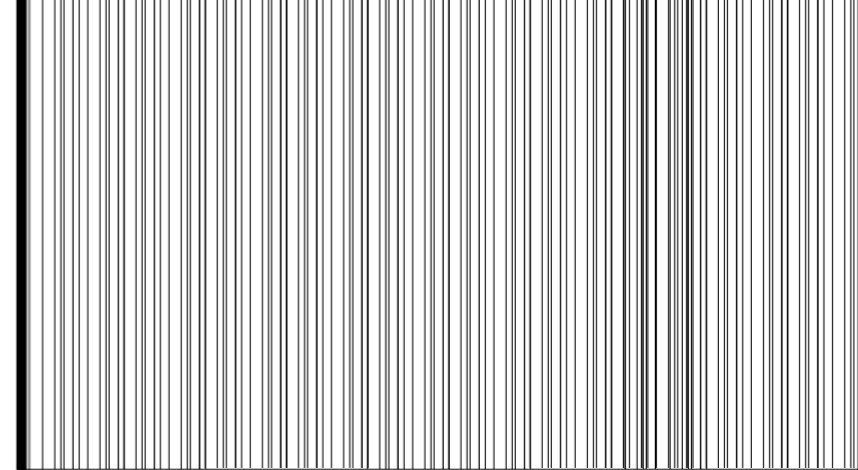

Straight
Grain Side

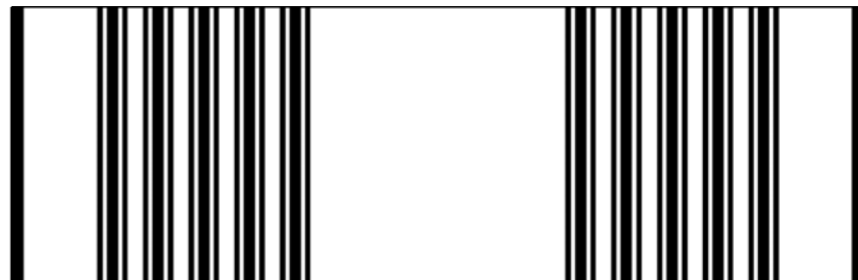
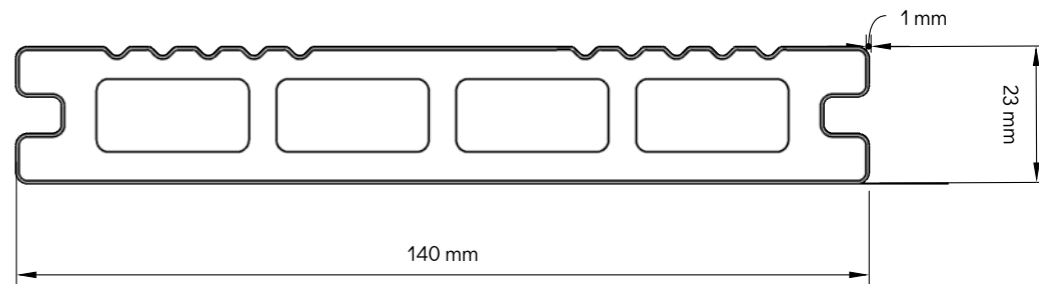

Traditional
Groove Side

LINEA COMPOSITE DECKING

Dual sided boards, traditional groove on one side, straight grain on the other.

Onyx

23mm x 140mm x 3600mm

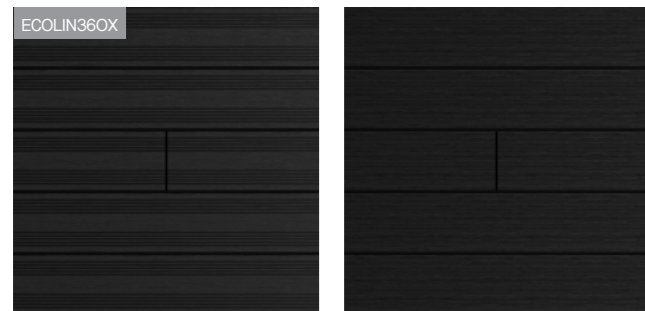

Slate

23mm x 140mm x 3600mm



Granite

23mm x 140mm x 3600mm



Umber

23mm x 140mm x 3600mm



UMBER
Linea
Composite
Decking



NEW

LINEA COMPOSITE DECKING ACCESSORIES

Angle Trim

40mm x 40mm x 3600mm

ECOLINATXX



8mm trim thickness

Flat Fascia Trim

15mm x 150mm x 3600mm

ECOLINFAXX



Dual sided

Solid Edge Trim

23mm x 140mm x 3600mm

ECOLINSOLXX



Dual sided

Hidden Screws & Composite Plugs

Screw: ECO09HS
Plug: ECOCPXX



NEW

Hidden T- Clip Fixings

250pcs, incl screws & 1 drill bit

ECO09CS



Locking Clip Fixings

50pcs, incl screws

ECO09LC



Start/Finish Clips

50pcs

ECO09SF



Colour Coded Screws

63mm/40mm

63mm: ECO09CSXX
40mm: ECO09CSXX40



BENEFITS OF LINEA DECKING

Low price point

Environmentally conscious design using 95% ethically sourced materials

Durable capping for UV and stain resistance

Low maintenance – no need to paint, stain or seal

Does not rot, warp or splinter

Natural looking without many of the drawbacks of timber

Easy installation system with invisible fixings

GRANDE COMPOSITE DECKING

CHATEAU
Grande Composite
Decking



Similar to our Forma range, our Grande decking boards are made up of 95% recycled material and uses advanced co-extrusion technology which generates an externally durable outer layer.

As the name suggests, the Grande board is 50% wider than a standard decking board at 225mm – for an elegant and contemporary look – which has the added benefit of being quicker to fit.

DOVETAIL
Grande Composite
Decking



Our capped technology and advanced brushing techniques create a composite decking board with exceptional anti-slip values, is UV stable and comes with a 25 year guarantee.

Grande is dual sided with the warm light grey Dovetail colour on one side and beige coloured Chateau on the other. Each side has a natural looking woodgrain finish.

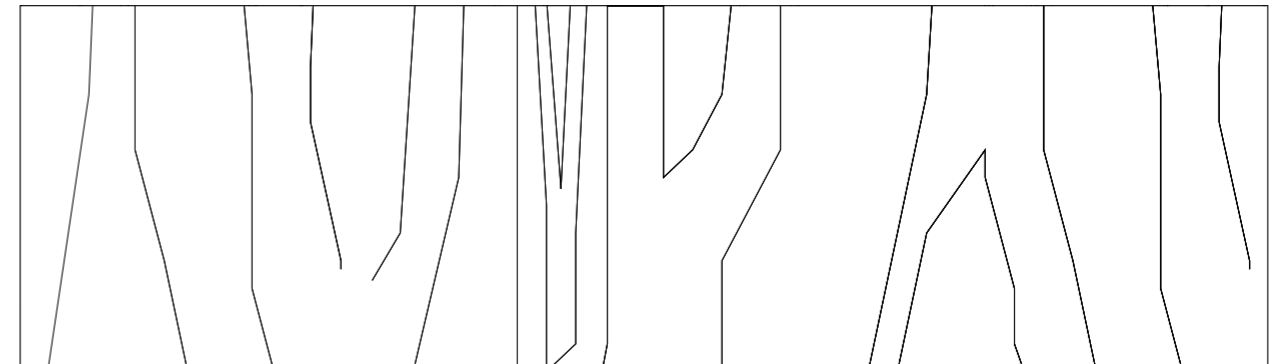
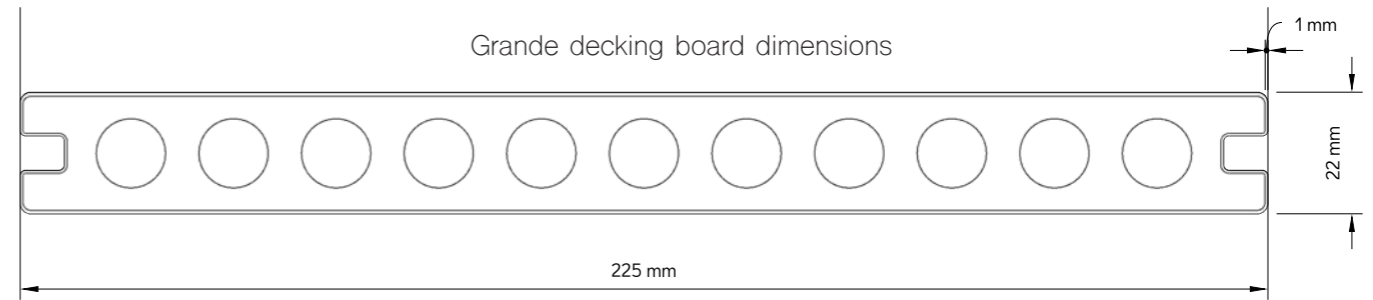
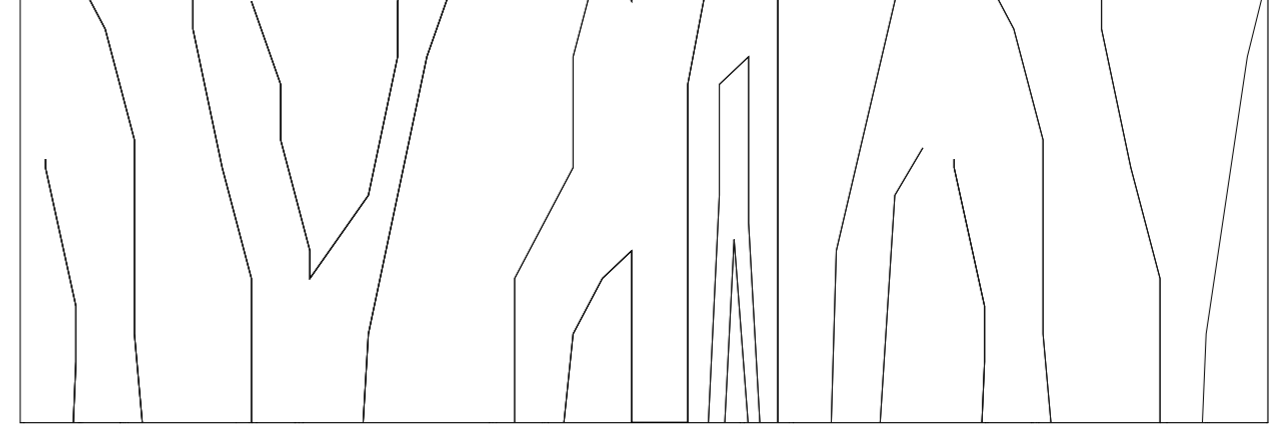

GRANDE COMPOSITE DECKING

Chateau
22mm x 225mm x 3600mm

ECOG225CD



Dovetail
22mm x 225mm x 3600mm

ECOG225CD



CHATEAU
Grande Composite
Decking

GRANDE COMPOSITE DECKING ACCESSORIES

Angle Trim
50mm x 50mm x 3000mm

ECOG50CH/DT



Flat Fascia Trim
15mm x 150mm x 3000mm

ECOG15CH/DT



Solid Edge Board
22mm x 225mm x 3600mm

ECOSOL225CH/DT



Composite Plugs & Hidden Screws

Screw: ECO09HS
Plug: ECOCPXX

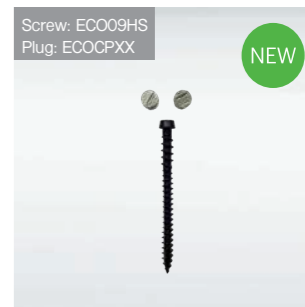

Hidden T-Clip Fixings
250pcs, incl screws & 1 drill bit

ECO09CS



Locking Clip Fixings
50pcs, incl screws

ECO09LC

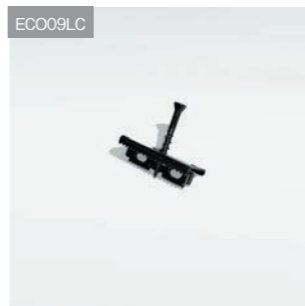

Start/Finish Clips
50pcs

ECO09SF

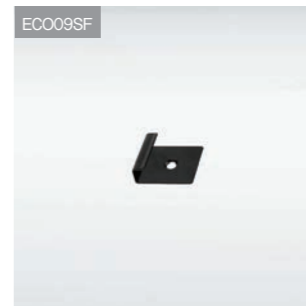

Colour Coded Screws
63mm/40mm

63mm: ECO09CSXX
40mm: ECO09CSXX40

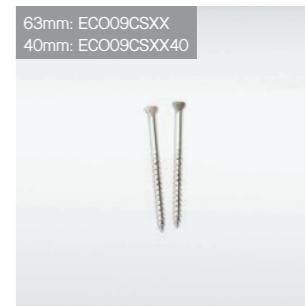



MIDNIGHT
Forma Composite
Panel Cladding



FORMA[®]
COMPOSITE
PANEL
CLADDING

Ecoscape Forma® composite panel cladding is a long lasting, low maintenance alternative to timber that can be used on various exterior projects; from home renovation to new build apartments, sunrooms or contemporary garden rooms.

Our cladding is made up of recycled high density polyethylene plastic and reclaimed wood fibres. With a durable polymer outer shell encapsulating the board, it forms an impermeable layer that offers protection from scratching and fading.

ARGENT
Forma Composite
Panel Cladding



Our tongue and groove capped cladding profiles are available in six colours, utilise a hidden fixing system and have a choice of six finishing trims.



SPICED OAK
Forma Composite
Panel Cladding



SILVER BIRCH
Forma Composite
Panel Cladding



Panel cladding
board dimensions

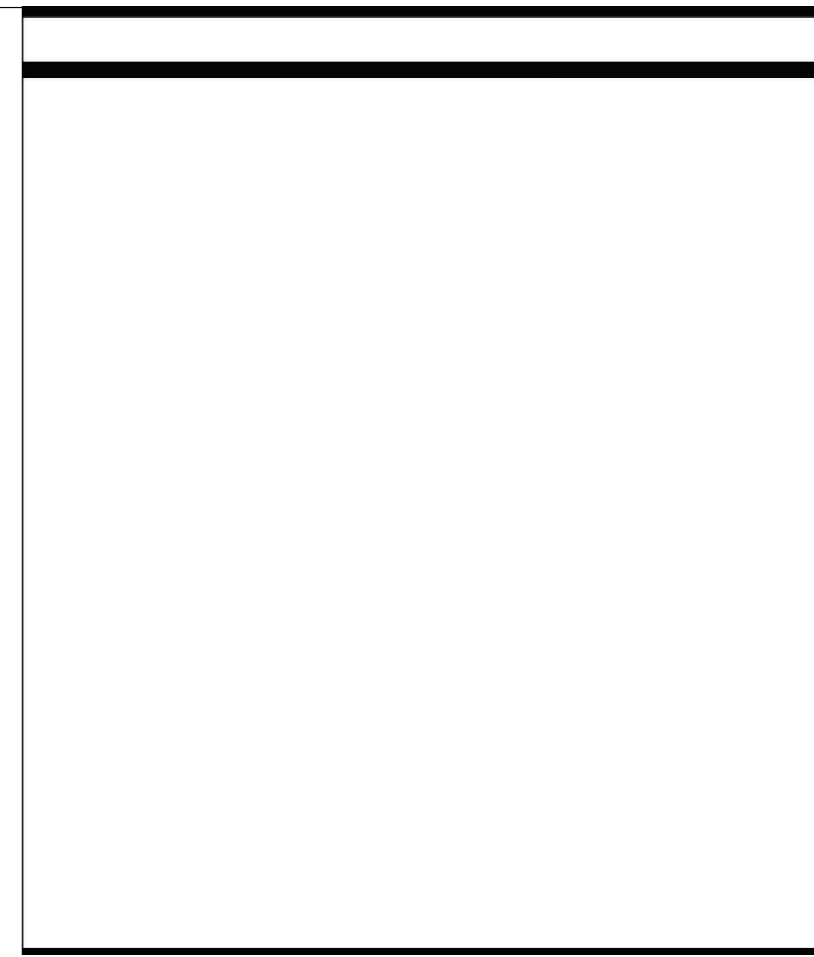
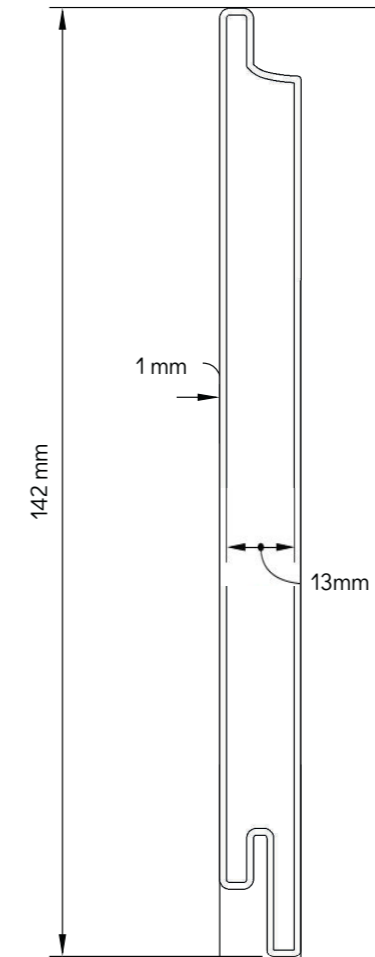

FORMA® COMPOSITE PANEL CLADDING

Havana

13mm x 142mm x 3600mm
Finished face 134mm

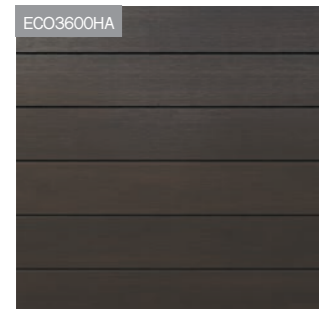

Silver Birch

13mm x 142mm x 3600mm
Finished face 134mm

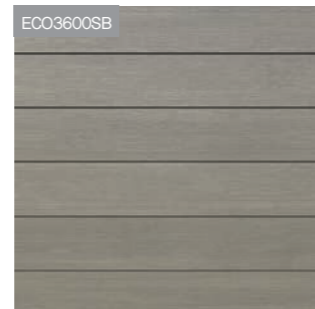

Flint

13mm x 142mm x 3600mm
Finished face 134mm



Argent

13mm x 142mm x 3600mm
Finished face 134mm

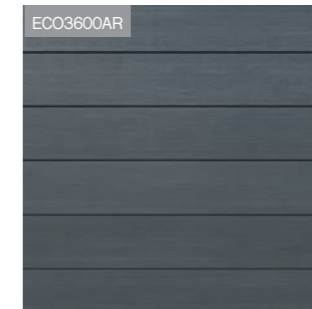

Spiced Oak

13mm x 142mm x 3600mm
Finished face 134mm

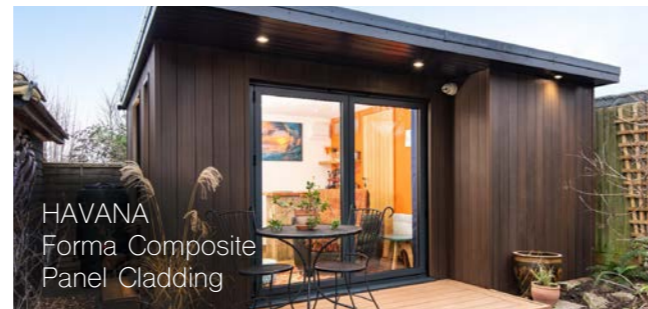
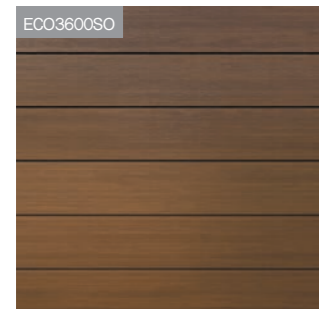

Midnight

13mm x 142mm x 3600mm
Finished face 134mm

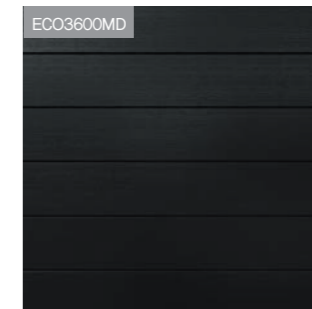

FORMA® COMPOSITE PANEL CLADDING TRIMS & ACCESSORIES

F Shape End Trim

47mm x 47mm x 3600mm
Finished face 25mm x 47mm

ECO4746XX



Angle Trim

40mm x 40mm x 3000mm
8mm trim thickness

ECO18XX3



Internal Corner Trim

72mm x 72mm x 3600mm
Finished face 24mm x 24mm

ECO7272XX



Panel Reveal Trim

47mm x 160mm x 3600mm
Finished face 25mm x 160mm

ECO47160XX



External Corner Trim

58mm x 58mm x 3600mm
Finished face 40mm x 40mm

ECO5858XX



Joint Trim

24mm x 79mm x 3600mm
Finished face 40mm

ECO7924XX

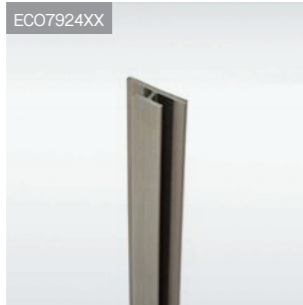

Finishing Board

15mm x 80mm x 3600mm

ECO8015XX



Aluminium Cladding Clips

250pcs

ECO701CC



Aluminium Starter Bar

3000mm

ECO702SB



Plastic Pad

8mm x 18mm

ECO703PP

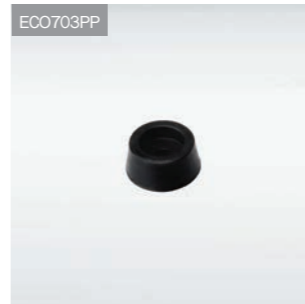

Wood Screw

For Cladding Clip
250pcs

ECO704CW



Locking Screw

For Cladding Clip
50pcs

ECO704LCCP

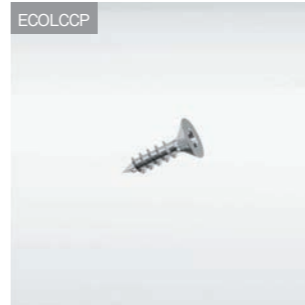

ARGENT
Forma Composite
Panel Cladding





NEW

FORMA®
COMPOSITE
SLATTED
CLADDING

LIGHT OAK
Forma Composite
Slatted Cladding

47

NEW

NATURAL OAK
Forma Composite
Slatted Cladding



Forma® slatted cladding is the perfect addition to any garden, extension or renovation and can instantly transform any project into a luxury space.

This stunning material from the capped Forma range takes inspiration from natural timber cladding with no need to paint, stain or oil. All of our Forma cladding products come with a 25 year warranty.



SPICED OAK
Forma Composite
Slatted Cladding



SILVER BIRCH
Forma Composite
Slatted Cladding



Slatted cladding
board dimensions

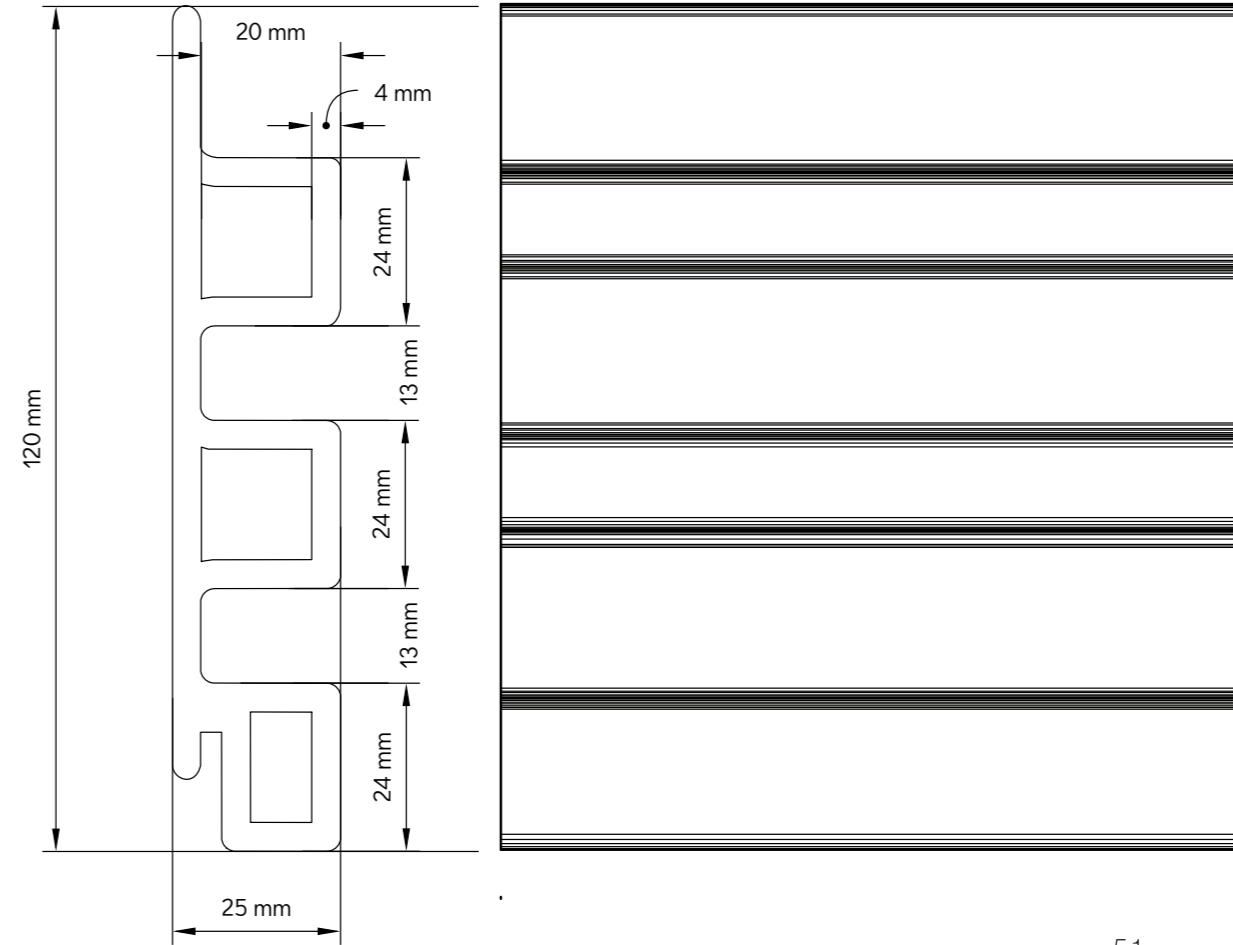

FORMA® COMPOSITE SLATTED CLADDING



Midnight

25mm x 120mm x 2500mm
25mm x 120mm x 3600mm

2.5m: ECOSLAT25MD
3.6m: ECOSLATMD



Finished Face 112mm



Silver Birch

25mm x 120mm x 2500mm
25mm x 120mm x 3600mm

2.5m: ECOSLAT25SB
3.6m: ECOSLATSB



Finished Face 112mm



Light Oak

25mm x 120mm x 2500mm
25mm x 120mm x 3600mm

2.5m: ECOSLAT25LO
3.6m: ECOSLATLO



Finished Face 112mm



Spiced Oak

25mm x 120mm x 2500mm
25mm x 120mm x 3600mm

2.5m: ECOSLAT25SO
3.6m: ECOSLATSO



Finished Face 112mm



Argent

25mm x 120mm x 2500mm
25mm x 120mm x 3600mm

2.5m: ECOSLAT25AR
3.6m: ECOSLATAR



Finished Face 112mm



Natural Oak

25mm x 120mm x 2500mm
25mm x 120mm x 3600mm

2.5m: ECOSLAT25NO
3.6m: ECOSLATNO



Finished Face 112mm



FORMA® COMPOSITE SLATTED CLADDING TRIMS & ACCESSORIES

Slatted Corner Trim

45mm x 78mm x 3600mm
Finished face 25mm x 25mm

ECOSLATXXCT



Slatted End Trim

54mm x 75mm x 3600mm
Finished face 25mm x 54mm

ECOSLATXXET



Finishing Board

15mm x 80mm x 3600mm

ECO8015XX



Angle Trim

40mm x 40mm x 3000mm
8mm trim thickness

ECO18XX3



Slatted Reveal Trim

75mm x 160mm x 3600mm
Finished face 25mm x 160mm

ECOSLATXXRT

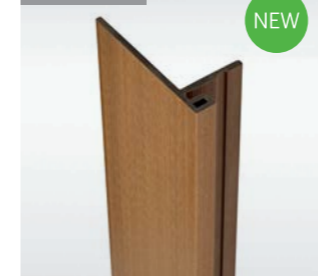

Aluminium Cladding Clips

250pcs

ECO701CC



Aluminium Starter Bar

3000mm

ECO702SB



Wood Screw

For Cladding Clip
250pcs

ECO704CW



Locking Screw

For Cladding Clip
50pcs

ECOLCCP



Plastic Pad

8mm x 18mm

ECO703PP



Use our new Reveal Trim to seamlessly frame deep windows and doorways in composite material

NEW

LIGHT OAK
Forma Composite
Slatted Cladding

MIDNIGHT
Forma Composite
Slatted Cladding



BENEFITS OF FORMA® CLADDING

Environmentally conscious design using 95% ethically sourced materials

Durable capping for UV and stain resistance

Low maintenance – no need to paint, stain or seal

Does not rot, warp or splinter

Natural looking without many of the drawbacks of timber

Easy installation system with invisible fixings

Extensive 25 year warranty

CLARITY® COMPOSITE FENCING & GATES



Ecoscope's range of composite fencing and gates are an innovative modular WPC profile which stack to create any desired height. This creates a bespoke long lasting, low maintenance alternative to timber fence panels.

Fence boards can either be retrofitted between existing fence posts or can be utilised in the fully composite post system; the perfect way to transform any garden into in to a luxury space.

This versatile system offers flexibility and style but also maintains the same environmentally friendly ethos as our other composite ranges and is made up of the same high quality recycled HDPE plastic and reclaimed wood fibres.

CHARCOAL
Clarity Composite
Fencing & Gate

Fence board dimensions

Dual surface boards with 3 x 38mm battens on one side and 2 x 63mm battens on the other.

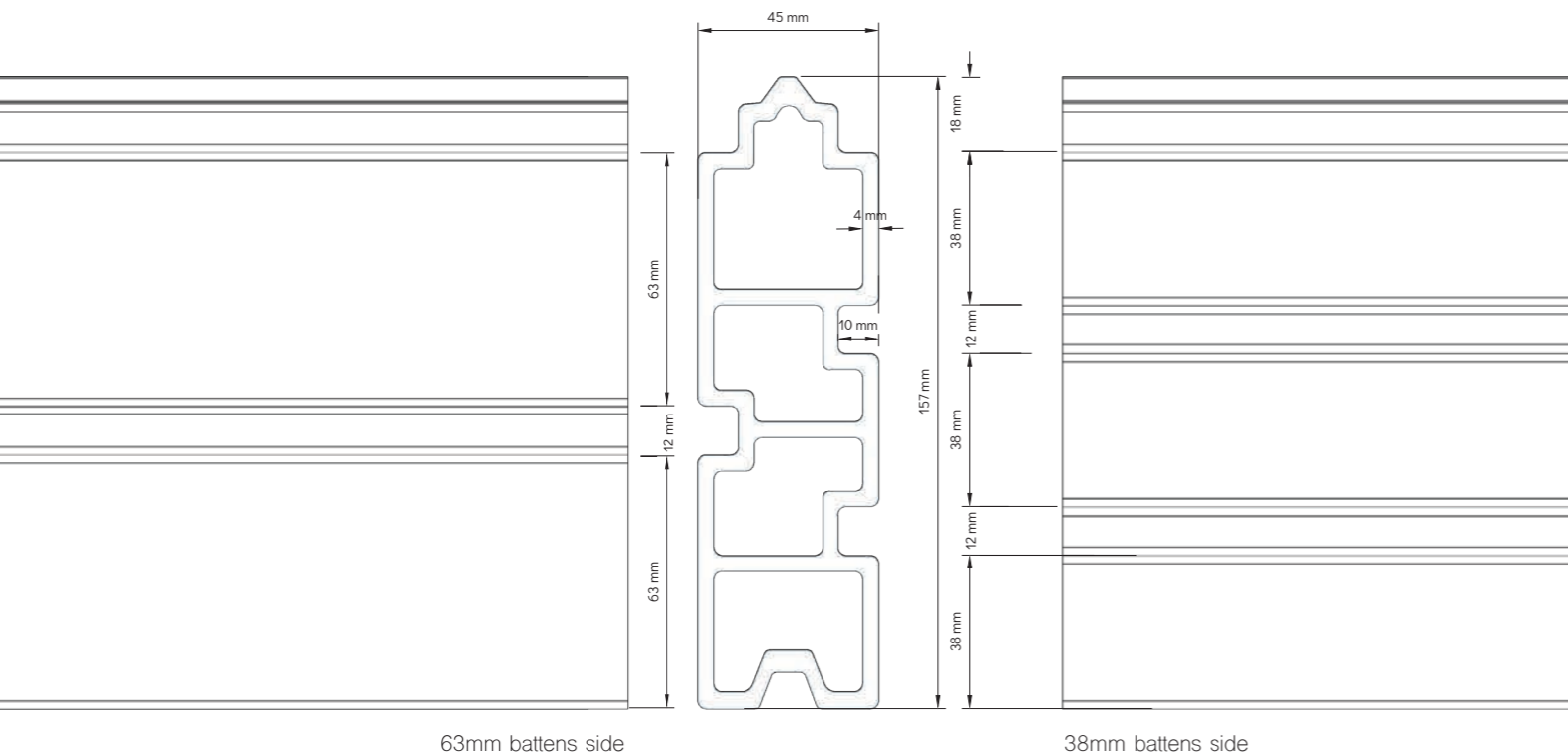

CLARITY® COMPOSITE FENCE BOARDS



Walnut

45mm x 157mm x 1830mm



Graphite

45mm x 157mm x 1830mm



Charcoal

45mm x 157mm x 1830mm

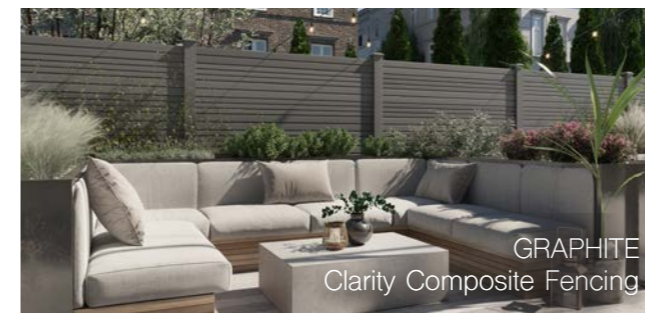

NOTE: Lighter Clarity boards will show greater colour settling due to smaller quantities of dye and greater UV exposure to the natural wood fibres. After 3 months of UV exposure colour remains consistent.

CLARITY® COMPOSITE FENCE COMPONENTS

Top Board
45mm x 139mm x 1830mm



End Post
125mm x 125mm x 1940/3000mm



Inter Post
125mm x 125mm x 1940/3000mm



Corner Post
125mm x 125mm x 1940/3000mm



Post Cap
23mm x 145mm x 145mm



Aluminium Bottom Rail
45mm x 52mm x 1830mm



Black Steel Fence Base Plate with Fixing Bolts & Caps
125mm x 190mm x 900mm



Steel Post Insert
55mm x 55mm x 1940/3000mm



Plastic Holder / Security Clip
Aluminium bottom rail support (pair)



Full Top Cap
23mm x 145mm x 4000mm

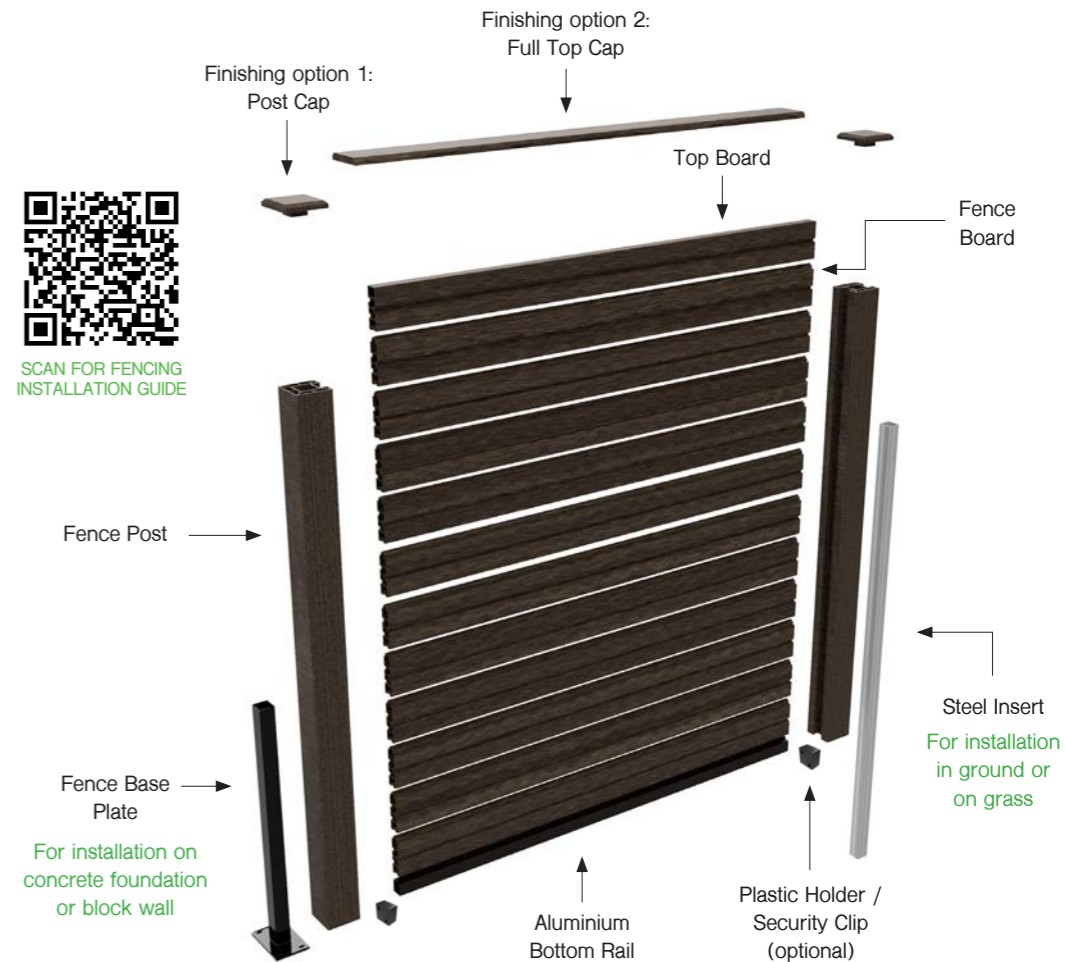

CLARITY® COMPOSITE GATES

“4ft” Charcoal/Graphite/Walnut
52mm x 900mm x 1220mm

ECOCXX122



Graphite shown

“5ft” Charcoal/Graphite/Walnut
52mm x 900mm x 1520mm

ECOCXX152



Walnut shown

“6ft” Charcoal/Graphite/Walnut
52mm x 900mm x 1820mm

ECOCXX182



Charcoal shown



SCAN TO VIEW
OUR COMPOSITE
GATES VIDEO

Our preassembled gates come with a black powder coated aluminium frame and are fitted with high quality hinges, handle and lock, ready to hang onto Ecoscape fence posts or equivalent. The gates are dual sided with 63mm battens on one side and 38mm battens on the other.

BENEFITS OF COMPOSITE FENCING & GATES

Modular system allowing for multiple design options.

3 Natural colours with matching gates in 4ft, 5ft & 6ft

Environmentally conscious design using 95% ethically sourced materials

Suitable for new project or retrofit between existing concrete posts

Quick and easy installation system

Strong and durable, storm resistant, 45mm thick boards

Extensive 20 year warranty

BALUSTRADE SYSTEMS



SCAN TO VIEW
BALUSTRADE
BROCHURE

MODA BLACK
Aluminium Balustrade
System with Glass

VITRA - Stainless Steel with Glass

Brushed finish, available base fixed or side fixed

With handrail



● Also available in black

Without handrail



● Also available in black

U Channel - Aluminium with Glass

Satin anodised finish, various installation options available

With handrail



● Also available in black

Without handrail



● Also available in black



VITRA Black
stainless steel
balustrade system
with glass.

MODA - Aluminium with Glass

Satin anodised finish, available base fixed or side fixed

With handrail



● Also available in black

Without handrail



● Also available in black

BALUSTRADE SYSTEMS

CLARITY® - Composite Balustrade

Available in the 5 Clarity colours

Full composite



With S/S handrail & glass infill



Also available with wire infills

CORDA - S/S with Wire

Brushed finish



● Also available in black

Titan - S/S with Glass

Various finishes available



TITAN
Spigot, stainless steel

Juliette Balcony

Available in a range of finishes and installation options



liteRAIL Aluminium

Black finish, 1000m height



Nb. for use up to 600mm height

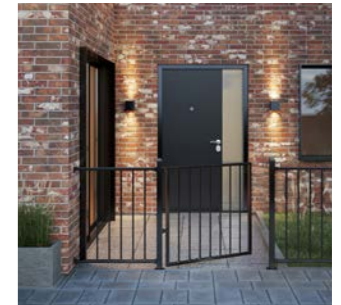

forzaRAIL Galvanized Steel

Textured black finish, 1100mm height



Step compatible



CRADLE & PEDESTAL SYSTEMS

MITO
JOIST
CRADLE

All of our cradle and pedestal systems are made in Italy from 100% recycled polypropylene, our pedestals also come with anti-noise rubber coated heads, using advanced electric injection presses which release no emissions or waste oil.

Our five ranges include King, Queen, Junior and Lord pedestals and our new Mito cradles, all beautifully boxed in our 100% FSC® packaging. Our ranges come with a 15 year limited warranty and 40+ year design life. We have 10 European registered patents, with our technology being unique to the market.

Across the five ranges you have the choice of self-levelling base supports, self-levelling heads and fixed supports, complete with a range of tools and ancillaries to cater for most laying issues and needs.

For technical information visit www.ecoscape.co.uk

“The market’s only recycled polypropylene support with a load capacity exceeding 1800kg”



KING
K5 Paving Pedestals



MITO JOIST CRADLE

Our new Mito decking joist cradle is a stable and secure system with stackable extensions, providing a support with adjustable heights from as low as 12mm up to 102mm. Thanks to the adjustment ring the height can be adapted in increments of millimetres, satisfying every height need with the help of only 2 items.

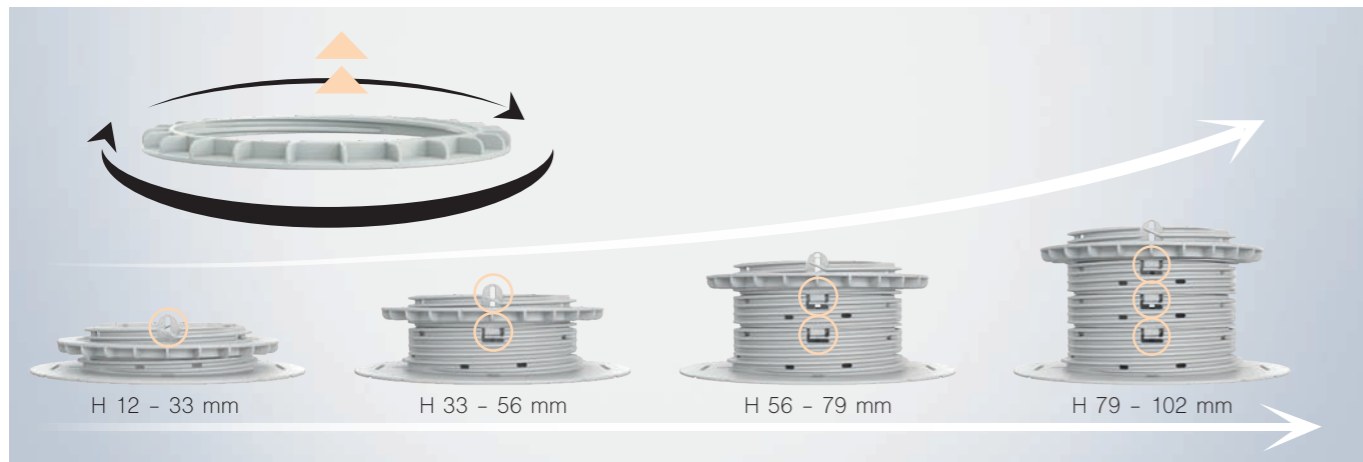

The Mito base and extensions are equipped with a double fixing hook which attaches the extensions with a simple pressure. Mito also features a maximum height safety block, which interrupts the movement of the adjustment ring when it reaches the top, always guaranteeing the loading capacity needed for the flooring.

MITO JOIST CRADLE

Joist Cradle System

12mm - 102mm height

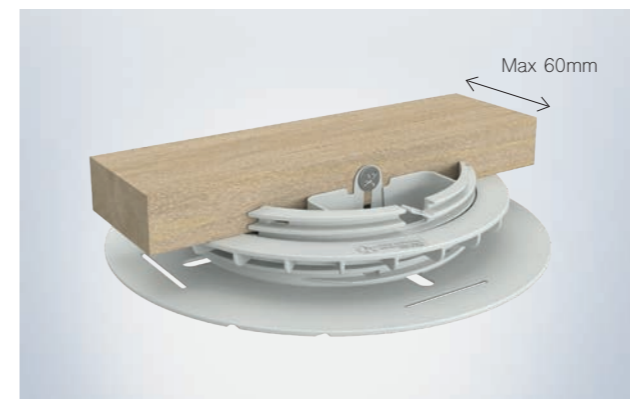
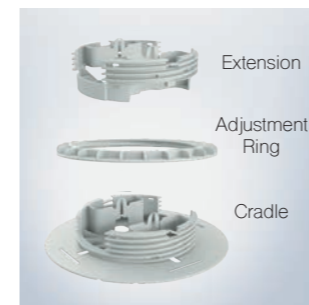

Mito Sizes

Description	Height
Mito Joist Cradle (incl. adjustment ring)	12-33mm
Mito Extension	33-56mm

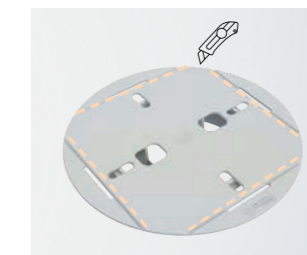

The base on Mito comes with pre-cut lines which allow the user to easily adapt the cradle for corners and walls, providing efficient installation and stability in every situation.

The Mito cradle is designed to suit decking joists up to 60mm in width, which are attached with simple wood screws positioned in correspondence with the appropriate central eyelets on the cradle.



KING PEDESTALS

This revolutionary patented pedestal is adjustable in height and allows the installer to choose between fixed or self-levelling base, just by twisting the converter located under the tower. The self-levelling base allows for maximum accuracy of adjustment and this additional function can correct level differences up to 5% of the surface.

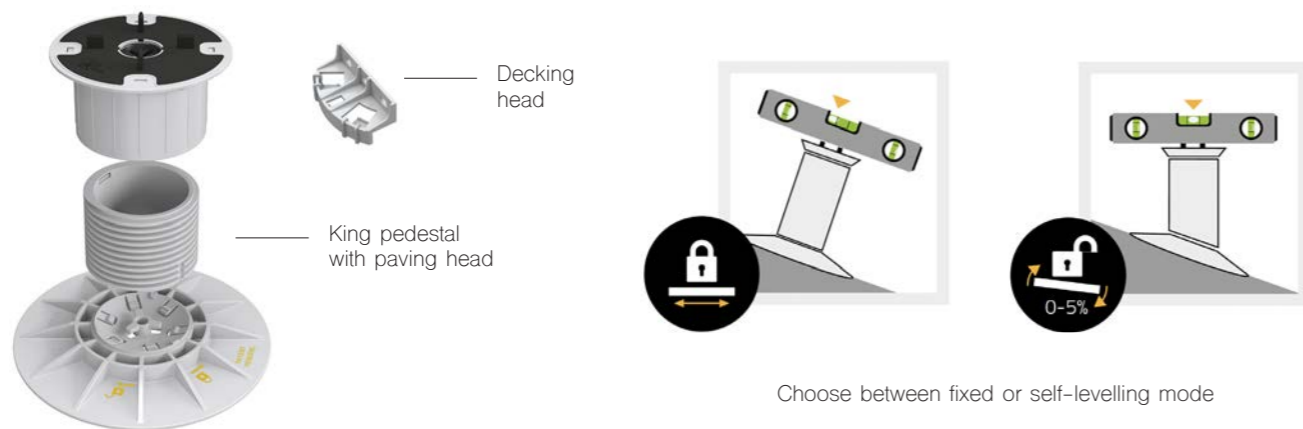

All of our pedestals are made up of 100% recycled high-quality polypropylene to create a sustainable and durable reinforced base and impact resistant screw. The King pedestal is the market's only recycled polypropylene support with a load capacity exceeding 1800kg.

KING PEDESTALS

Decking Pedestal

K1 30mm - K15 1089mm height



Paving Pedestal

K1 30mm - K15 1089mm height



King Pedestal Sizes

Decking/Paving

Composition	Height
P1 King Extension	113mm
K1	30mm-41mm
K2	41mm-63mm
K3	63mm-95mm
K4	95mm-152mm
K5	152mm-209mm
K6 (K4 + P1)	159mm-272mm
K7 (K5 + P1)	216mm-329mm
K8 (K4 + P1 + P1)	224mm-380mm
K9 (K5 + P1 + P1)	280mm-436mm
K10 (K5 + P1 + P1 + P1)	340mm-545mm

Can be stacked all the way to K15



P1 King Extension, 113mm height, allowing King pedestals to reach heights of 1500mm+.

QUEEN PEDESTALS

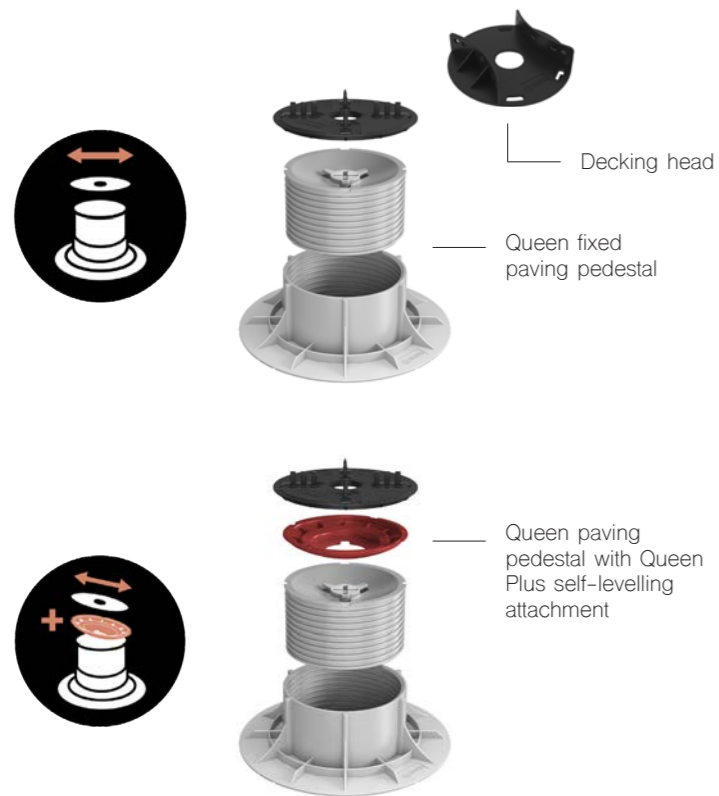

Queen is a reliable and durable raised floor support that is adjustable in height, with a fixed head. Ideal for multi-level renovations and projects that require operating at low heights. The Queen's minimum elevation height is just 21mm, through to 1000mm+.

With the application of a simple component between the screw and head, the Queen Plus attachment offers the option of self-levelling at the head to correct slopes of up to 5%. This transitions the Queen pedestal from fixed to a simple and practical self-levelling support.

QUEEN PEDESTALS

Decking Pedestal
Q1 21mm - Q15 1224mm height



Paving Pedestal
Q1 21mm - Q15 1224mm height

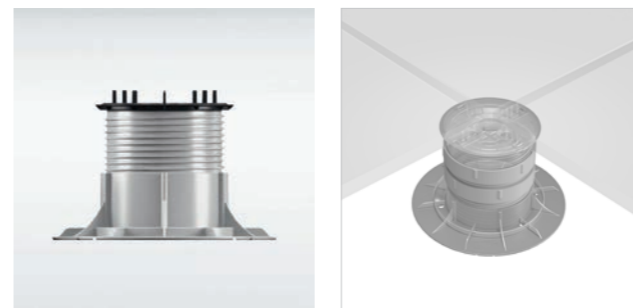

Queen Pedestal Sizes
Decking/Paving

Composition	Height
QTS Queen Short Extension	23mm-30mm
QTL Queen Long Extension	64mm-110mm
QUEEN PLUS Self-levelling head	7mm
Q1	21mm - 30mm
Q2	29mm - 44mm
Q3	43mm - 72mm
Q4	70mm - 126mm
Q5	124mm - 234mm
QP1 (Q1 + QUEEN PLUS)	28mm - 37mm
QP2 (Q2 + QUEEN PLUS)	36mm - 51mm
QP3 (Q3 + QUEEN PLUS)	50mm - 79mm
QP4 (Q4 + QUEEN PLUS)	77mm - 133mm
QP5 (Q5 + QUEEN PLUS)	131mm - 241mm

Can be stacked all the way to Q15/QP15

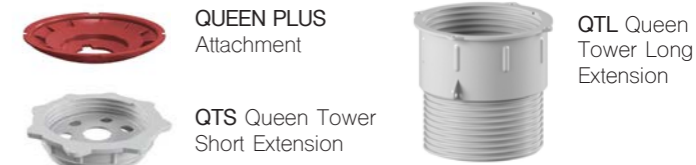

JUNIOR PEDESTALS

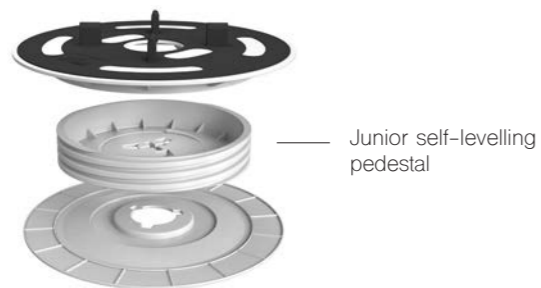

Junior self-levelling pedestal

Junior is an extremely low 12mm to 30mm support with a self-levelling head and functions without additional extensions. The movement of the screw runs between the head and the base which allows easy levelling of the floor and capable of adjusting slopes of up to 1.5%.

Junior Paving Pedestal
J1 12mm - J3 30mm height



Junior Pedestal Sizes
Suitable for paving systems only

Composition	Height
J1	12mm - 18mm
J2	18mm - 24mm
J3	24mm - 30mm

LORD MODULAR CRADLES

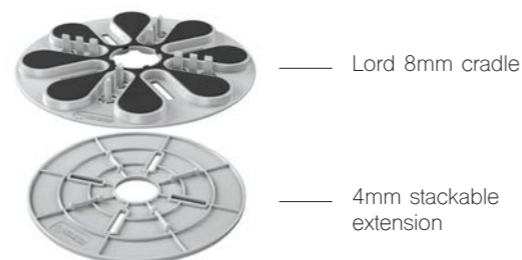

Lord 8mm cradle

4mm stackable extension

Lord cradles are fixed at 8mm and can be heightened by increments of 4mm when adding the Lord extension beneath the support. Lord is an effective solution in minor adjustment renovations and in all projects where very low heights are required.

Lord Paving Cradle
8mm height + 4mm height extension



Lord Sizes
Suitable for paving systems only

Composition	Height
Lord	8mm
Extension	4mm

Stack up to 3 extensions.

FORTE TIMBER FREE SUBSTRUCTURES

Using only the highest grade 100% recycled plastics we produce extremely strong and durable plastic joists/battens as an alternative to using a timber substructure. With profiles suitable for both decking and cladding these solutions are especially beneficial in the damp British climate where timber can be compromised in a matter of a few years.

We also offer a recycled aluminium support system. Extremely light weight and durable – aluminium does not warp, shrink, swell like timber and remains perfectly straight throughout its 80+ year lifespan. The recycling process only takes up 5% of the energy used during its manufacturing and the quality of recycle aluminium is the same as that of new.



FORTE TIMBER FREE JOISTS, BATTENS & ACCESSORIES

Plastic Decking Joist
50mm x 50mm x 2400mm

ECOPL5050



Plastic Decking Joist
50mm x 125mm x 3000mm

ECOPL12550



Plastic Decking Post
100mm x 100mm x 3000mm

ECOPL100100



Plastic Cladding Battens
25mm x 50mm x 3000mm
20mm x 100mm x 2800mm

ECOPL2550 / ECOPL20100



Aluminium Joist
40mm x 40mm x 3600mm

ECOALUJ4040

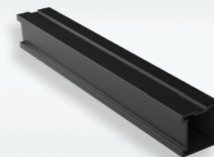

Aluminium Joist
25mm x 70mm x 2000mm

ECOTECHTRAIL

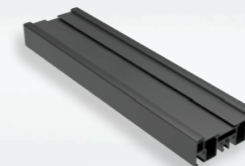

For use in conjunction with our decking and paving pedestals

Cladding/Decking Tape
54/100mm width, 20m length

ECOTAPE54X20 / ECOTAPE100X20



Our weatherproof Cladding/Decking Tape preserves your timber cladding or decking frame to match the lifespan of our composite boards.

Made from recycled plastic, the tape is repositionable, self-seals, comes with a 25 year warranty and can even be applied to damp timber or below freezing temperatures.

NEW

OUTDOOR KITCHENS



Our new outdoor kitchen range is made from powder coated aluminium and polywood and is available in 4 colour schemes that will complement any garden style. This modular range consists of a versatile sink unit and a set of 3 units with a trolley, a cabinet and a worktop, all with convenient under counter shelving and storage. Each piece functions independently, allowing users to customise the layout of their outdoor cooking space. All units come with a grey weatherproof cover.



SMOKE
Dark grey woodgrain & RAL 9005



TAUPE
Dark beige woodgrain & RAL 7006



OAK
Oak effect woodgrain & RAL 7021

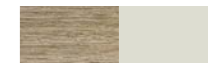

COTTON
Light beige woodgrain & RAL 9002

SET OF 3 UNITS

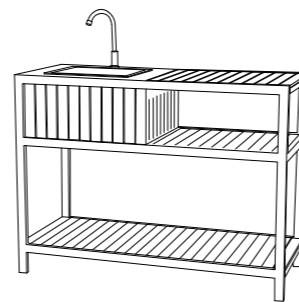

Sink Unit

Including a high quality stainless steel sink and a single lever black tap.

H:95cm x W:127cm x D:53cm

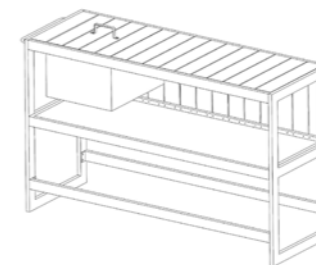

Worktop

With built in ice bucket & towel rail and hooks on the side

H:91cm x W:146cm x D:50cm



Cabinet

With cupboard doors & gold effect knobs

H:91cm x W:70cm x D:50cm

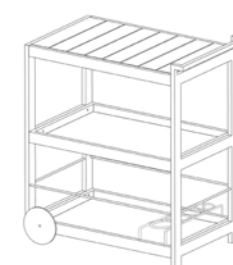

Trolley

With bottle holders, wheels & handle

H:91cm x W:84cm x D:50cm

OUTDOOR KITCHENS

Sink Unit - Smoke

Incl. sink & tap

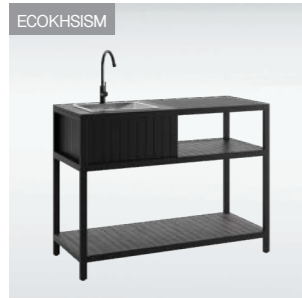

Set of 3 Units - Smoke

Worktop unit with ice bucket (1), Cabinet (2) & Trolley (3)



Sink Unit - Taupe

Incl. sink & tap



Set of 3 Units - Taupe

Worktop unit with ice bucket (1), Cabinet (2) & Trolley (3)



Sink Unit - Oak

Incl. sink & tap



Set of 3 Units - Oak

Worktop unit with ice bucket (1), Cabinet (2) & Trolley (3)

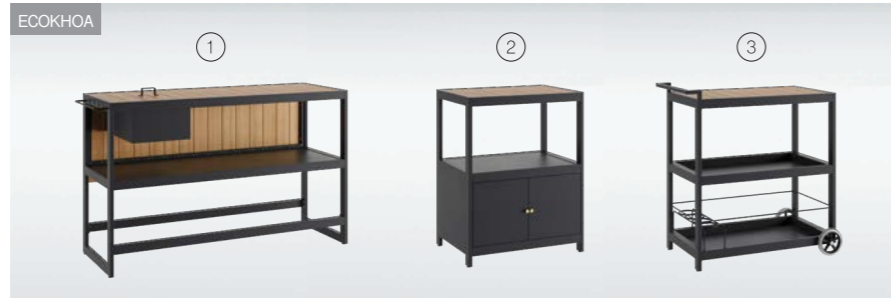

Sink Unit - Cotton

Incl. sink & tap



Set of 3 Units - Cotton

Worktop unit with ice bucket (1), Cabinet (2) & Trolley (3)



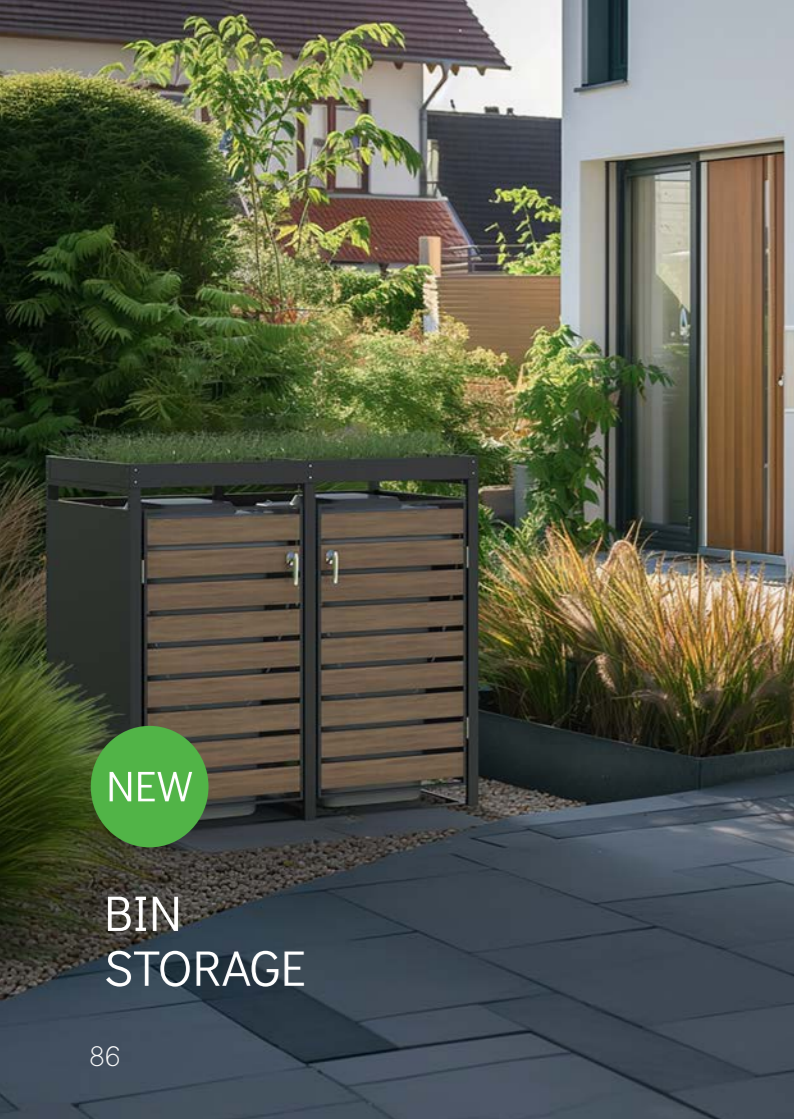

NEW

BIN STORAGE

Hide your bins away with our discreet galvanised steel units. Available with a spring opening lid with a hook to lift the bin lid, or a planter top. Both options include stainless steel handles with a hidden lock, magnets for door closure and holes on both sides to connect multiple units together. Available in two colour options.



WOODGRAIN &
CHARCOAL
Double bin storage
with planter top

BIN STORAGE WITH PLANTER:



The planter roof offers the perfect opportunity to add some greenery to enhance your outdoor area. The chain mechanism enables effortless tipping of the waste bin, facilitating disposal without removing it from storage.

BIN STORAGE WITH SOFT CLOSE LID:



The lid is equipped with gas springs and pressure dampers, along with a hook and chain system for effortless lifting and convenient waste disposal.

FEATURES:

- Sturdy and durable
- Weatherproof & corrosion free
- Body made of powdercoated galvanised steel
- Option of charcoal finish (RAL7021) or charcoal with woodgrain effect doors
- Stainless steel door handles with hidden locks
- Magnets to hold doors in place securely
- Individual modules with holes on the sides for connecting multiple units
- Suitable for 60L, 120L & 240L wheelee bins.

DIMENSIONS	CM
Single with planter	W68 x D80 x H124
Double with planter	W132 x D80 x H124
Triple with planter	W200 x D80 x H124
Quadruple with planter	W264 x D80 x H124
Single with lid	W68 x D80 x H116
Double with lid	W132 x D80 x H116
Triple with lid	W200 x D80 x H116
Quadruple with lid	W264 x D80 x H116

BIN STORAGE

Single Bin Storage
with Lid

Charcoal



Double Bin Storage
with Lid

Charcoal



Triple Bin Storage
with Lid

Charcoal



Quadruple Bin Storage
with Lid

Charcoal



Single Bin Storage
with Planter

Charcoal



Double Bin Storage
with Planter

Charcoal



Triple Bin Storage
with Planter

Charcoal



Quadruple Bin Storage
with Planter

Charcoal



Single Bin Storage
with Lid

Woodgrain & Charcoal



Double Bin Storage
with Lid

Woodgrain & Charcoal

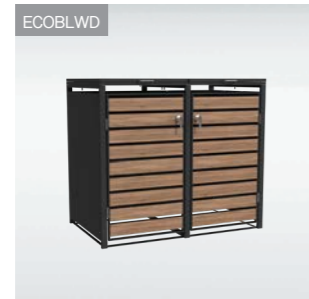

Triple Bin Storage
with Lid

Woodgrain & Charcoal



Quadruple Bin Storage
with Lid

Woodgrain & Charcoal



Single Bin Storage
with Planter

Woodgrain & Charcoal



Double Bin Storage
with Planter

Woodgrain & Charcoal



Triple Bin Storage
with Planter

Woodgrain & Charcoal



Quadruple Bin Storage
with Planter

Woodgrain & Charcoal



COTTON
Outdoor Kitchen

NEW



ACCESS OUR ONLINE RESOURCES

Scan the QR codes with the camera on your mobile device to view our pdf guides and videos.



DECKING
GUIDE



PANEL CLADDING
GUIDE



SLATTED CLADDING
GUIDE



FENCING
GUIDE



GATES
GUIDE



HELPFUL
VIDEOS



SKETCHUP
3D WAREHOUSE

NEW

Linea
Composite
Decking

“OUR NEWEST CAPPED
DECKING BOARD – AT OUR
LOWEST PRICE POINT,”

ecoscape.co.uk

01706 364 637

sales@ecoscape.co.uk